

Carding
Clothing for spinning



Clothing for Spinning

No limits in processing fibers



No Limits in Processing Fibers





Graf is the world's leading supplier of clothing for carding and combs for combing machines in the short- and long-staple spinning industry, as well as for producers and machine builders for nonwovens. The company's core competency lies in its ability to process textile fibers of any kind, using the precise processing of steels and elastomers to manufacture high-tech components like flexible flats and metallic clothing for flat- and roller cards.

Working from five manufacturing locations worldwide, Graf's high level of vertical integration and local support helps customers achieve superior quality and performance across the full spectrum of fiber processing. Graf + Cie AG, headquartered in Rapperswil (Switzerland), is a subsidiary of the Rieter Group.

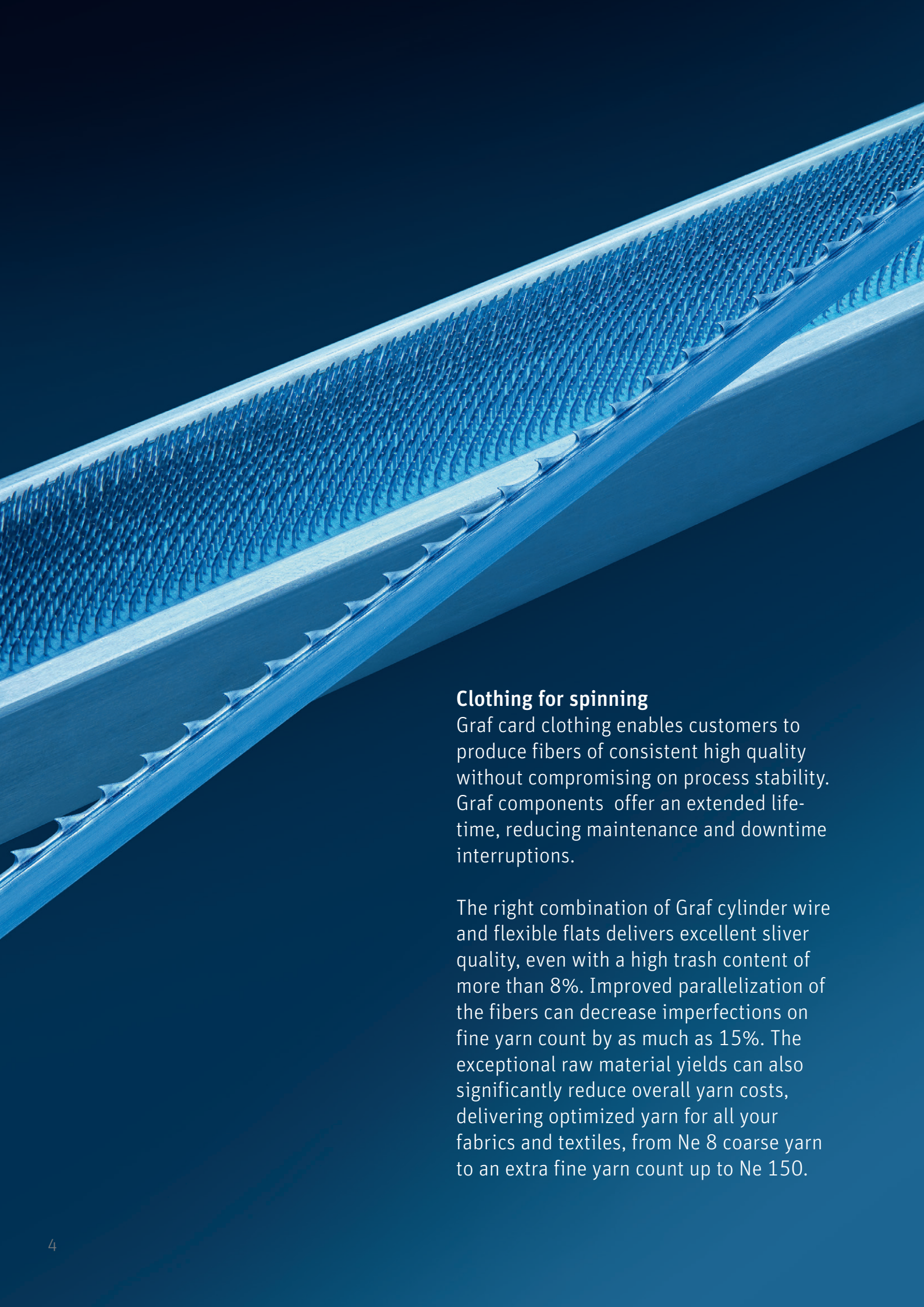

Clothing for spinning

Graf card clothing enables customers to produce fibers of consistent high quality without compromising on process stability. Graf components offer an extended life-time, reducing maintenance and downtime interruptions.

The right combination of Graf cylinder wire and flexible flats delivers excellent sliver quality, even with a high trash content of more than 8%. Improved parallelization of the fibers can decrease imperfections on fine yarn count by as much as 15%. The exceptional raw material yields can also significantly reduce overall yarn costs, delivering optimized yarn for all your fabrics and textiles, from Ne 8 coarse yarn to an extra fine yarn count up to Ne 150.

Contents

6	Card components	
7	Metallic card clothing	
8	General information on metallic card clothing	
10	Graf identification code for metallic card clothing	
12	Surface treatments	
13	Alloys	
14	Carding overview	
17	Flexible flats	

19	Overview of flat clothing	
20	EasyTop	
22	Stationary flats	
25	Cleaning and stripping fillets	
26	Clothing for blowroom	
27	Clothing for OE opening rollers	
28	Accessories	
30	Smart and flexible service packages	



Card Components

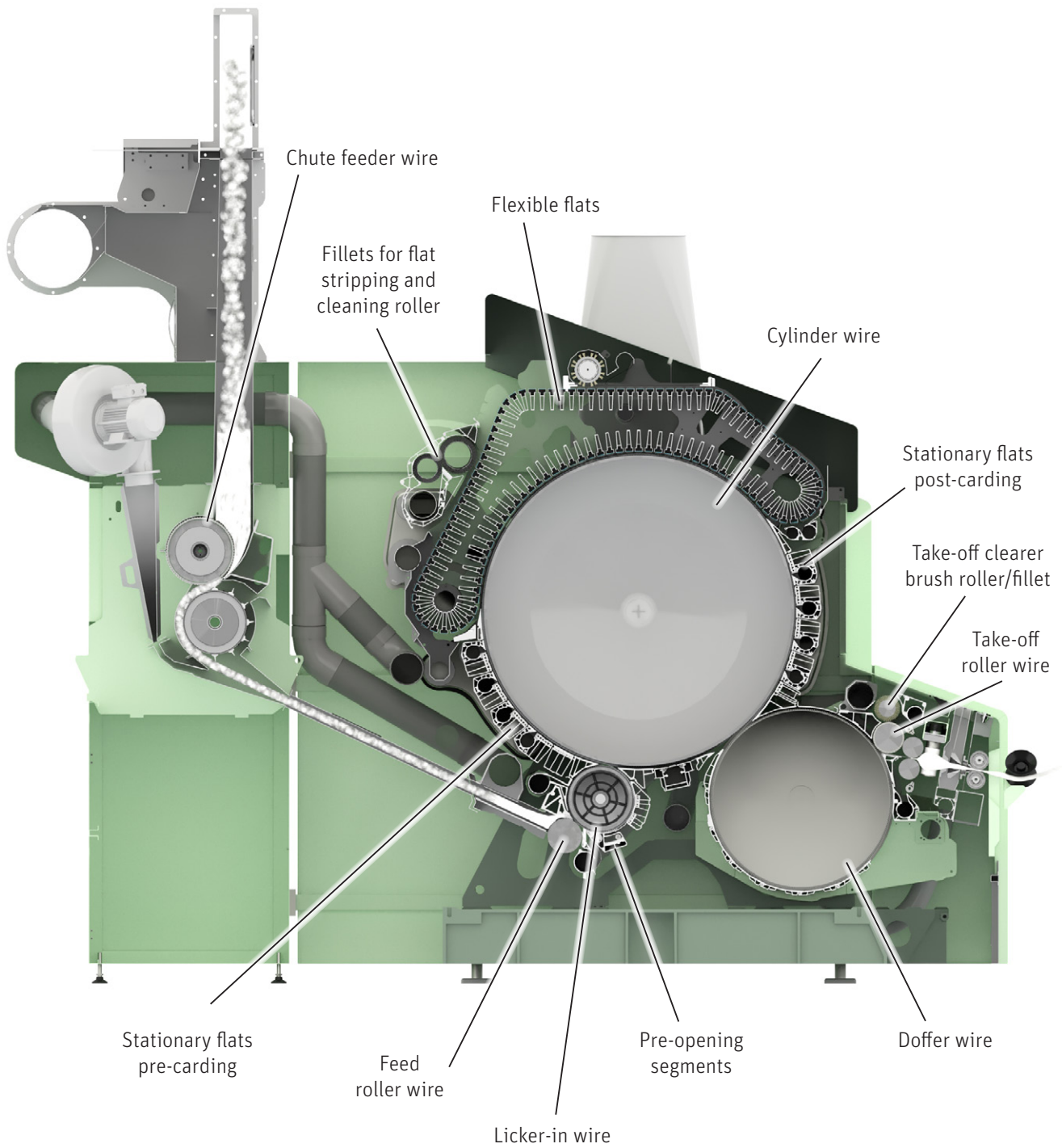

Metallic Card Clothing

Gentle to fibers and designed for consistent sliver quality plus high process stability

Carding wires from Graf are particularly gentle to fibers. Designed for consistent sliver quality and high process stability, they also offer an exceptionally long lifetime. Graf carding wires are suitable for cotton, man-made and regenerated fibers and will work across a wide range of carding applications, with numerous manufacturer systems and technologies.

The Graf portfolio covers carding wires for the widest possible range of card models and their demanding applications.

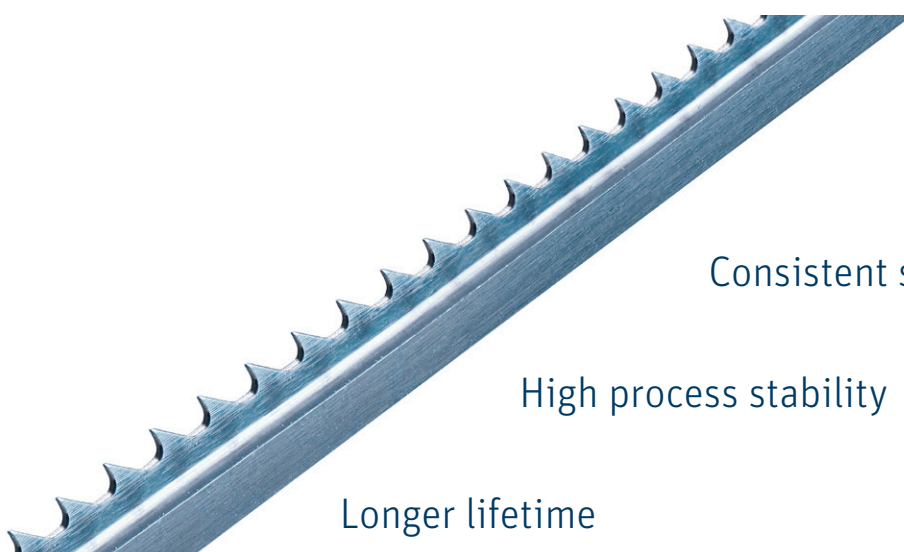

Consistent sliver quality

High process stability

Longer lifetime

Benefits of Graf metallic card clothing

One of the daily challenges for spinning mills is creating consistent yarn quality from raw materials with significant variations.

- Graf card clothing enables customers to produce fibers of equal quality without compromising on lifetime and process stability, even with higher levels of contaminated cotton. Increasing short fiber content can be easily achieved with the right Graf product.
- Graf carding wires work with cotton, cotton blends, man-made or recycled fibers in any condition. Full flexibility delivers optimized yarn for all fabrics and textiles, from Ne 8 coarse yarn to extra fine count yarn up to Ne 150.
- Cards and their components are at the heart of a spinning mill and are crucial for the quality of the yarn. Graf metallic card clothing meets that need thanks to its Swiss engineered design for consistent sliver quality plus high process stability.

General Information on Metallic Card Clothing

Cylinder clothing

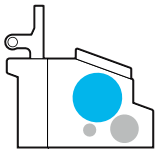

The cylinder roller is the key to every carding machine. Cylinder clothing takes over the fibers from the licker-in and is responsible for the main carding action with the flexible flats.

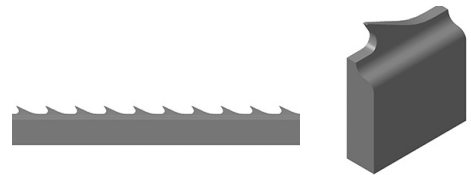

Clothing height and breast angle

1.9 mm	Short-toothed clothing for application on all cards. The specific Swiss engineered shape prevents the loading of the clothing with seed coat fragments and trash.
2.0 mm	
2.5 mm	Metallic card clothing for universal application on conventional cards and for man-made fibres < 3 dtex
15° – 20°	For clothing used on conventional cards or for processing man-made fibers at low production rates
25° – 40°	For short-toothed clothing on high-performance cards

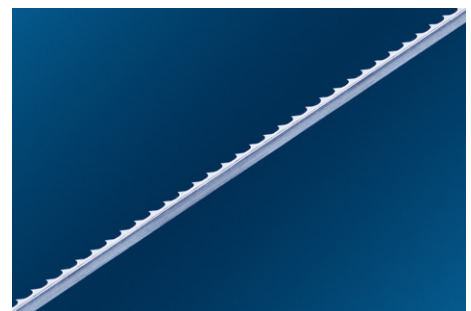

Licker-in clothing

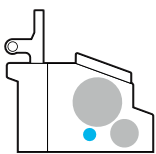

The licker-in wires are responsible for opening the fiber batt in the revolving flat card and transferring the opened fibers to the cylinder. Trash is removed at the licker-in. A gentle and even opening of the fibers at the licker-in is essential for the card sliver and yarn quality.

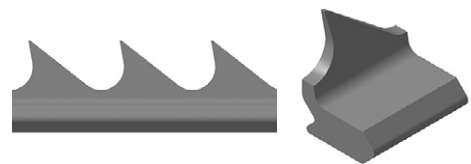

Clothing height and breast angle

5.0 mm	Interlinked clothing
5.5 mm	Groove-wound and interlinked clothing
0°	Card-specific for man-made blends, polyester and viscose, single or 1st licker-in wires
5°	For fine man-made fibers ≤ 1 dtex, for viscose ≤ 2 dtex, long staple cotton and blends of cotton/man-made fibers
10°	For cotton and for cotton ring yarn OE Ne 15 – 30
20°	Card-specific for cotton and man-made fiber, 2nd and 3rd licker-in wires

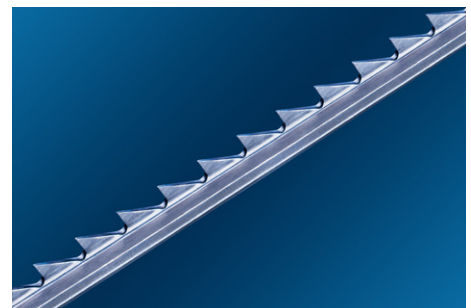

Doffer clothing

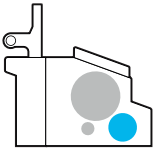

The doffer wire takes over the fibers from the cylinder. The transfer ratio and the uniform transfer of the fibers are important for achieving an optimal carding result. The quality of the doffer wire, in conjunction with precise settings, determines the smooth function of the fiber take-up from the cylinder to the doffer.



Clothing height and breast angle

4.0 mm	For universal application
4.6 mm	For card-specific application
30°	Universal application for processing of cotton and man-made fibers. Most suitable for high production rates
35° and 40°	For man-made fibers and blends, most suitable for high production rates
Clothing with serration (SER)	Used for man-made fibers and blends, particularly for fibers with low adhesion
Clothing with arched tooth (B)	Application for optimum fiber adhesion

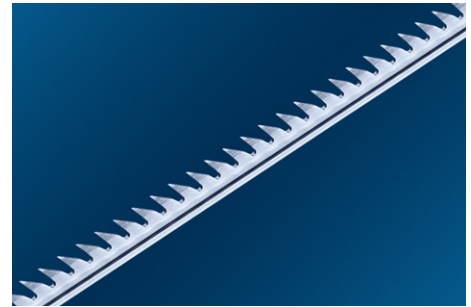

Graf Identification Code for Metallic Card Clothing

Standard profiles



P	20	+40	S	X0,4	CS	BLH	45
Tooth pitch	Height	Working angle	Tooth shape*	Base width	Material quality*	Surface treatment*	Coil size 45 kg
	2.0 mm	40°		0.4 mm			

Interlinked profiles



V	D	50	+10	E1	14	CS	BLD	45
Interlinked	Tooth pitch	Height	Working angle	Tooth shape*	Number of threads/inch	Material quality*	Surface treatment*	Coil size 45 kg
		5.0 mm	10°					

*Tooth shapes

- B = arched tooth shape
- C = camel
- F = flat tooth
- G = beak-shaped tooth
- M = morel
- S = special cut depth
- V = licker-in profile
- W = execution with humps
- blank = standard tooth shape
- 1 – 9 = special tooth shape



*Surface treatments

- BLD = blank disc polished
- BLH = blank hardened
- NF = needle finish
- POL = polidur
- SER = serrated profile
- SER BLD = serrated profile + blank disc polished
- SER BLH = serrated profile + blank hardened
- SER NF = serrated profile + needle finish
- SER POL = serrated profile + polidur

*Material qualities

- GT = G Three
- HT = High Tech
- CS = CUTTYSHARP
- MS = MULTISHARP

Examples for points per square inch (p.p.s.i.)

Standard profiles	p.p.s.i.
G2 40 -28 1 X1,8 GT	107
L 40 +30 B X1,0 GT	278
M 46 +30 1 X1,0 GT SER BLH	304
N 40 +30 B X0,9 GT	366
P 20 +25 X0,5 HT	773
R 20 +30 X0,5 HT	866
P 20 +40 S X0,4 HT	966
Interlinked profiles	p.p.s.i.
V E 50 +10 V 8 HT	41
V J2 50 +10 V 12 HT	118
V K 50 +20 G 16 HT	161

Calculation example for P 20 +40 S X0,4 HT

$$966 \text{ p.p.s.i.} = \frac{645}{(25.4 \times 25.4) \times 0.4 \times 1.669}$$

(Base width in mm x tooth pitch in mm)

No. of threads/inch	Base width in mm
6	4.20
8	3.17
10	2.54
12	2.10
14	1.80
16	1.60
18	1.40
20	1.20
24	1.00
28	0.90
32	0.80

Pitch	Teeth/linear inch approx.	Pitch in mm
A1	1.25	20.024
A2	1.50	15.050
A3	1.75	14.930
B	2.00	12.727
B1	2.25	11.000
B2	2.50	10.012
B3	2.75	9.387
C	3.00	8.485
C1	3.25	8.000
C2	3.50	7.255
C3	3.75	6.953
D	4.00	6.364
D1	4.25	5.867
D2	4.50	5.442
D3	4.75	5.200
E	5.00	5.006
E2	5.50	4.470
F	6.00	4.242
F2	6.50	3.911
G	7.00	3.627
G2	7.50	3.337
H	8.00	3.129
H2	8.50	2.980
J	9.00	2.828
J2	9.50	2.607
K	10.00	2.502
L	11.00	2.317
M	12.00	2.121
N	13.00	1.956
O	14.00	1.813
P	15.00	1.669
R	17.00	1.490
T2	19.50	1.303

Surface Treatments

Blank hardened (BLH)



Treated clothing with a scalefree surface.

Blank disc polished (BLD)



Mechanical treatment for smoothing and refining the clothing surfaces. The running-in time is reduced to a minimum. Therefore, a consistently high quality is ensured right from the start.

Polidur treatment (POL)



Improved surface finish achieved with electrochemical polishing. The clothing is completely de-burred at the same time.

Needle finish (NF)



Best-in-class electrochemical polishing and rounding of all edges on the clothing teeth.

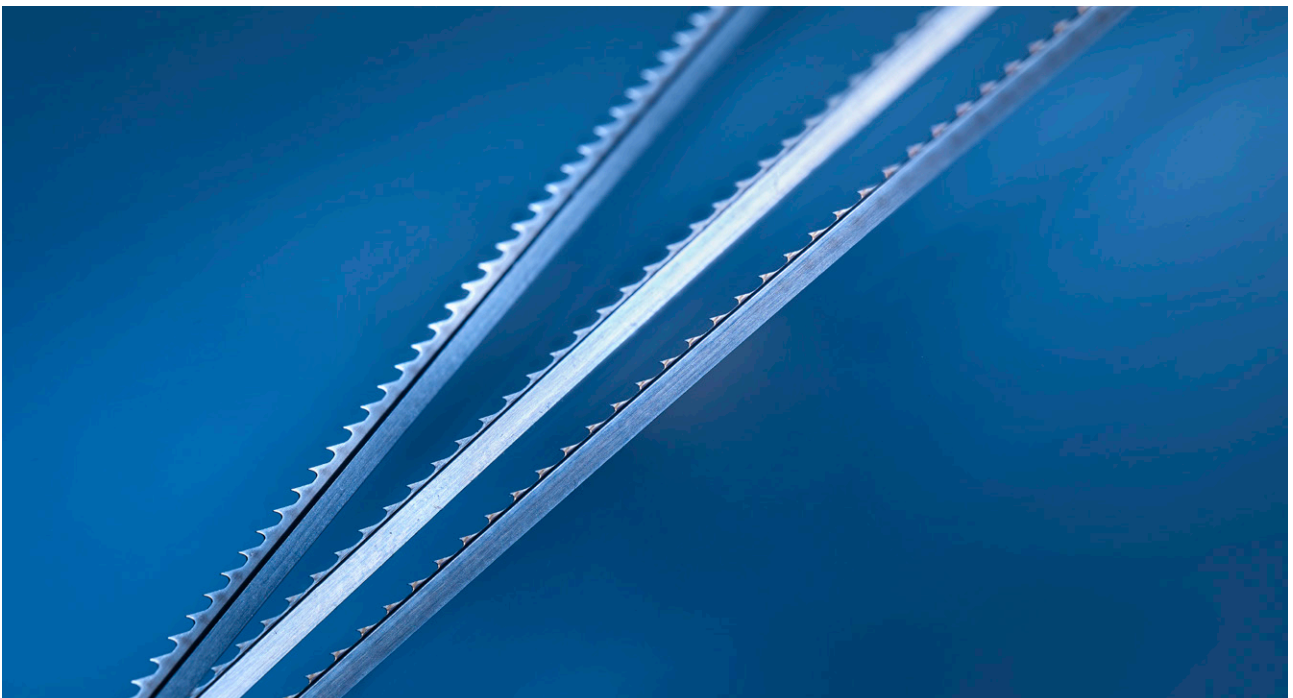

Alloys

MULTISHARP, CUTTYSHARP and HIGH TECH

Depending on the application demands, Graf can supply the following alloys:

MULTISHARP (MS)

The unique wear-resistant alloy MULTISHARP guarantees a longer lifetime, particularly when using abrasive synthetic fibers. MULTISHARP also ensures a consistently high carding performance across an extended lifetime of at least +50% compared to CUTTYSHARP alloy and less maintenance-induced downtime.

CUTTYSHARP (CS)

CUTTYSHARP is designed for the highest demands and lifetime up to 1 100 t for cylinder clothing. Recommended for card production rates of 50 kg/h and more.

HIGH TECH (HT)

HIGH TECH is a steel alloy with special additives, providing substantially increased lifetime compared to conventional clothing. Lifetime of up to 800 t can be easily achieved. Used for card production rates up to 50 kg/h.

Lifetime comparison of Graf alloys

OE Yarn Ne 20

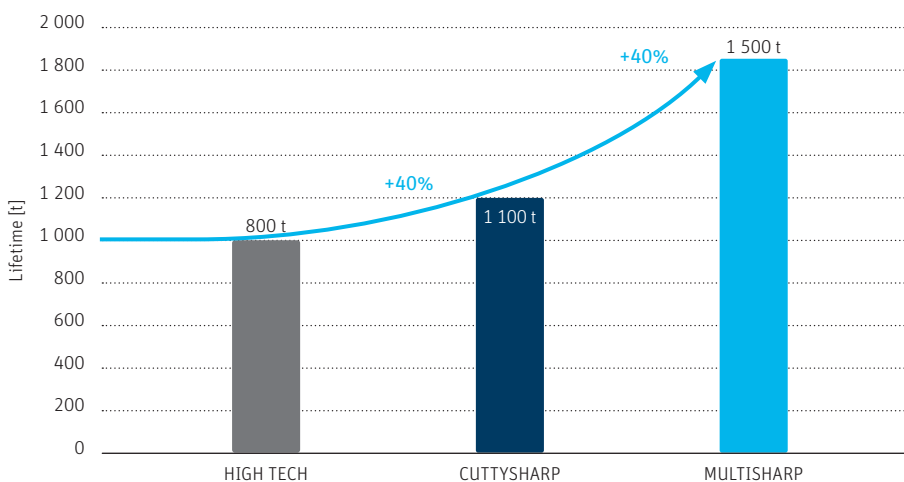

Carding Overview

Production rate	Roller	Cotton		
		OE yarn, < Ne 20	Carded ring yarn OE, < Ne 15 – 30	Ring yarn, Ne 24 – 40, ≤ 32 mm
< 50 kg/h	Cylinder	P 19 +40 S X0,4 HT	P 19 +40 S X0,4 HT	P 19 +40 S X0,4 HT
		P 20 +40 S X0,4 HT	P 20 +40 S X0,4 HT	P 20 +40 S X0,4 HT
		R 20 +30 X0,5 HT	R 20 +30 X0,5 HT	R 20 +30 X0,5 HT
	Doffer	N 40 +30 B X0,9 GT	N 40 +30 B X0,9 GT	N 40 +30 B X0,9 GT
		M 46 +30 1 X1,0 GT SER BLH	M 46 +30 1 X1,0 GT SER BLH	M 46 +30 1 X1,0 GT SER BLH
> 50 kg/h	Cylinder	P 19 +40 S X0,4 CS	P 19 +40 S X0,4 CS	P 19 +40 S X0,4 CS
		P 20 +40 S X0,4 CS	P 20 +40 S X0,4 CS	P 20 +40 S X0,4 CS
		R 20 +30 X0,5 CS	P 20 +35 C X0,4 CS	P 20 +35 C X0,4 CS
	Doffer		R 20 +30 X0,5 CS	R 20 +30 X0,5 CS
		N 40 +30 B X0,9 GT	N 40 +30 B X0,9 GT	N 40 +30 B X0,9 GT
		M 46 +30 1 X1,0 GT SER BLH	M 46 +30 1 X1,0 GT SER BLH	M 46 +30 1 X1,0 GT SER BLH
	Licker-in	V E 50 +10 V 8 HT	V E 50 +10 V 8 HT	V E 50 +10 V 8 HT
		V E 50 +10 V C 12 CS	V E 50 +10 V C 12 CS	V E 50 +10 V C 12 CS
		V K 50 +20 G 16 HT	V K 50 +20 G 16 HT	V K 50 +20 G 16 HT
		V J2 50 +10 V 12 HT	V J2 50 +10 V 12 HT	V J2 50 +10 V 12 HT
		E 55 +10 X1, ... HT	E 55 +10 X1, ... HT	E 55 +10 X1, ... HT

Production rate	Roller	Man-made fibers		
		Polyester (micro) ≤ 1,0 dtex ≤ 40 mm	Viscose (micro) ≤ 1,0 dtex ≤ 40 mm	Man-made fiber blends
< 50 kg/h	Cylinder	P 20 +25 X0,5 HT	P 20 +25 X0,5 HT	P 20 +25 X0,5 HT
			R 20 +25 1 X0,6 CS BLH	R 20 +25 1 X0,6 CS BLH
	Doffer	N 40 +30 B X0,9 GT SER	N 40 +30 B X0,9 GT SER	N 40 +30 B X0,9 GT SER
		M 46 +30 1 X1,0 GT SER BLH	M 46 +30 1 X1,0 GT SER BLH	M 46 +30 1 X1,0 GT SER BLH
> 50 kg/h	Cylinder	P 20 +25 X0,5 CS	P 20 +25 X0,5 CS	R 25 +25 X0,6 CS
			R 20 +25 1 X0,6 CS BLH	R 25 +20 X0,6 CS
				R 20 +25 1 X0,6 CS BLH
	Doffer	N 40 +30 B X0,9 GT SER	N 40 +30 B X0,9 GT SER	N 40 +30 B X0,9 GT SER
		M 46 +30 1 X1,0 GT SER BLH	M 46 +30 1 X1,0 GT SER BLH	L 46 +40 X1,0 GT SER BLH
		L 46 +40 X1,0 GT SER BLH		
	Licker-in	V D 50 0 V 8 CS	V D 50 0 V 8 CS	V D 50 0 V 8 CS
		V E 50 +5 V 8 HT	V E 50 +5 V 8 HT	V E 50 +5 V 8 HT
		V J2 50 +5 V 12 CS	V J2 50 +5 V 12 CS	V J2 50 +5 V 12 CS
		V K 50 +20 G 16 HT	V K 50 +20 G 16 HT	V K 50 +20 G 16 HT
		E 55 +10 X1, ... HT	E 55 +10 X1, ... HT	E 55 +10 X1, ... HT

Cotton

Ring yarn, Ne 40 – 70, ≤ 32 mm	Cotton/Waste, Waste ≥ 25%
P 19 +40 S X0,4 HT	R 20 +30 X0,5 HT
P 20 +40 S X0,4 HT	R 20 +30 X0,6 HT
R 20 +30 X0,5 HT	
N 40 +30 B X0,9 GT	L 46 +40 X1,0 GT SER BLH
M 46 +30 1 X1,0 GT SER BLH	
P 19 +40 S X0,4 CS	R 20 +30 X0,5 HT
P 20 +40 S X0,4 CS	R 20 +30 X0,6 HT
P 20 +35 C X0,4 CS	
R 20 +30 X0,5 CS	
N 40 +30 B X0,9 GT	L 46 +40 X1,0 GT SER BLH
M 46 +30 1 X1,0 GT SER BLH	M 46 +30 1 X1,0 GT SER BLH
V E 50 +10 V 8 HT	V E 50 +10 8 GT
V E 50 +10 V C 12 CS	V E 50 +10 V C 12 CS
V K 50 +20 G 16 HT	V K 50 +20 G 16 HT
V J2 50 +10 V 12 HT	V J2 50 +10 V 12 HT
E 55 +10 X1, ... HT	E 55 +10 X1, ... HT

Man-made fibers	Blends	Swing	Recycling
Viscose 1,0 – 2,0 dtex ≤ 51 mm	Cotton/ Man-made fibers	Cotton/ Man-made fibers	Cotton
P 20 +25 X0,5 HT	P 20 +25 X0,5 HT	P 20 +25 X0,5 HT	R 20 +30 X0,5 HT
R 20 +25 1 X0,6 CS BLH	R 20 +30 X0,5 HT	R 25 +25 X0,6 HT	R 20 +30 C X0,5 CS
	R 25 +25 X0,6 HT	R 20 +30 X0,6 HT	
N 40 +30 B X0,9 GT SER	N 40 +30 B X0,9 GT SER	N 40 +30 B X0,9 GT SER	N 40 +30 B X0,9 GT
M 46 +30 1 X1,0 GT SER BLH	M 46 +30 1 X1,0 GT SER BLH	M 46 +30 1 X1,0 GT SER BLH	M 46 +30 1 X1,0 GT SER BLH
R 20 +25 1 X0,6 CS BLH	P 20 +25 X0,5 CS	P 20 +25 X0,5 CS	R 20 +30 X0,5 CS
R 25 +25 X0,6 CS	R 20 +30 X0,5 CS	R 25 +25 X0,6 CS	R 20 +30 C X0,5 CS
	R 25 +25 X0,6 CS	R 20 +30 X0,6 CS	
L 46 +40 X1,0 GT SER BLH	N 40 +30 B X0,9 GT SER	N 40 +30 B X0,9 GT SER	N 40 +30 B X0,9 GT
M 46 +35 1 X1,0 GT SER BLH	M 46 +35 1 X1,0 GT SER BLH	M 46 +35 1 X1,0 GT SER BLH	M 46 +30 1 X1,0 GT SER BLH
M 46 +30 1 X1,0 GT SER BLH		M 46 +30 1 X1,0 GT SER BLH	
O 40 +30 X0,7 GT BLH			
V D 50 0 V 8 CS	V J2 50 +10 V 12 CS	V D 50 +5 V 8 HT	V J2 50 +10 V 12 HT
V E 50 +5 V 8 HT	V E 50 +10 V 8 HT	V E 50 +5 V 8 HT	V E 50 +10 V 8 HT
V J2 50 +5 V 12 CS	V J2 50 +5 V 12 CS	V J2 50 +5 V 12 CS	V J2 50 +10 V 12 HT
V K 50 +20 G 16 HT	V K 50 +20 G 16 HT	V K 50 +20 G 16 HT	V K 50 +20 G 16 HT
E 55 +10 X1, ... HT	E 55 +10 X1, ... HT	E 55 +10 X1, ... HT	E 55 +10 X1, ... HT



Flexible Flats

Flat clothing helps reduce short fibers and waste so that carding trough cylinder wire works optimally

Flexible flat clothing resist-O-top

Resist-O-top (RSTO) is a line of flexible flat clothing used for the processing of the whole range of short staple fibers (cotton, man-made fibers, blends and regenerated fibers). It is progressively set without any straight tip gaps.

This setting pattern influences the so-called free passage, resulting in an improved distribution of the carding forces and a positive effect on the position of the teeth.

The progressive setting pattern favors the removal of short fibers and waste as well as the elimination of neps. All types are available in clipped and in EasyTop version.

C-range for cotton and blends		M-range for man-made fibers and blends		R-range for recycling	
RSTO C-48	480 p.p.s.i. Raw material: cotton/blends Application: carded, combed OE rotor, Air-Jet < Ne 40	RSTO M-43	430 p.p.s.i. Raw material: man-made fibers/blends Application: Air-Jet > 1.0 dtex ≤ 2.0 dtex	RSTO R-40	400 p.p.s.i. Raw material: recycling
RSTO C-55	550 p.p.s.i. Raw material: cotton Application: combed, Air-Jet > Ne 24	RSTO M-48	480 p.p.s.i. Raw material: man-made fibers/blends Application: carded, Air-Jet > 1.0 dtex ≤ 2.0 dtex	RSTO R-44	440 p.p.s.i. Raw material: recycling/blends/waste (OE Ne < 24) 1.1 – 2.0 dtex
RSTO C-60	600 p.p.s.i. Raw material: cotton Application: combed Ne 40 – Ne 70	RSTO M-55	550 p.p.s.i. Raw material: man-made fibers/blends Application: carded, Air-Jet ≤ 1dtex		
RSTO C-74	740 p.p.s.i. Raw material: cotton Application: combed > Ne 70				

Flexible flat clothing PRIMATOP

The PRIMATOP (PRT) range includes flexible flat clothing intended for the processing of cotton and man-made fibers. The density is progressive, i.e. the entry side, seen in the direction of the fiber flow, is open, becoming continuously closer towards the exit side.

PRT 43	430 p.p.s.i. Raw material: viscose 1.1 – 2.0 dtex up to 51mm Application: OE ring, high production, Air-Jet < Ne 30
---------------	--

Flexible flat clothing InLine-X-Top

This setting pattern influences the so-called free passage, resulting in an improved distribution of the carding forces and a positive effect on the position of the teeth. InLine-X-Top (ILXT) is also available in EasyTop version.

ILXT M-40	400 p.p.s.i. Raw material: man-made fibers/blends 1.0 – 2.0 dtex Cotton bleached
------------------	---

Semi-rigid flat clothing PICCO DIAMANT

PICCO DIAMANT (PDI) is a semi-rigid flat clothing for the processing of recycling, bleached cotton, flax/linen or Kevlar/Nomex fibers. The special positioning of the teeth leads to minimal flat waste.

PDI 33	330 p.p.s.i. Raw material: recycling, bleached cotton, flax/linen, Kevlar/Nomex
---------------	---

Overview of Flat Clothing

Cotton

	Air-jet	OE/Rotor	Carded ring yarn	Combed ring yarn
< Ne 15	RSTO C-48	RSTO C-48	RSTO C-48	
≤ Ne 40	RSTO C-48 RSTO C-55	RSTO C-48 RSTO C-55	RSTO C-48 RSTO C-55	
> Ne 40				RSTO C-55 RSTO C-60
> Ne 70				RSTO C-74

Man-made fibers

	Polyester	Viscose	Swing	Blend cotton/ Man-made fibers	Recycling	Bleached cotton
< 1.0 dtex	RSTO M-55	RSTO M-55	RSTO M-55			
1.0 – 2.0 dtex	ILXT M-40 RSTO M-43 RSTO M-48 RSTO R-44	ILXT M-40 RSTO M-43 RSTO M-48 RSTO R-44	ILXT M-40 RSTO M-43 RSTO M-48	ILXT M-40 RSTO M-43 RSTO M-48 PRT 43	RSTO R-44 RSTO R-40 PDI 33	PDI 33
> 2.0 dtex	RSTO M-43	RSTO M-43	RSTO M-43	RSTO M-43		

Extract of the comprehensive range of Graf metallic card clothing

Application areas of the proven Graf flat clothing

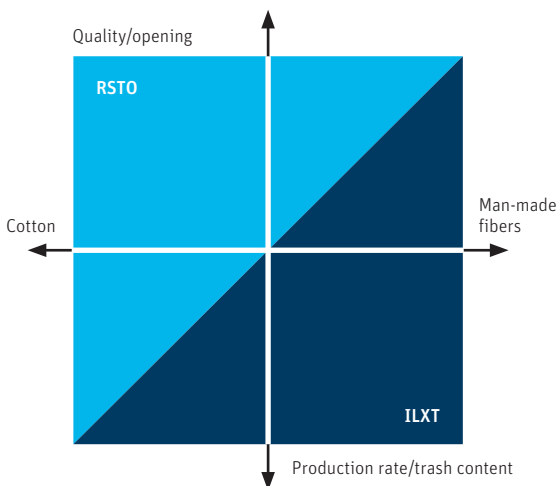

EasyTop

Innovative magnetic adhesion technology for fast and precise reclothing

To ensure consistently high quality in the carding process, regular replacement of the flat clothing is necessary. EasyTop allows fast replacement, reducing downtimes of the cards and the carding process.

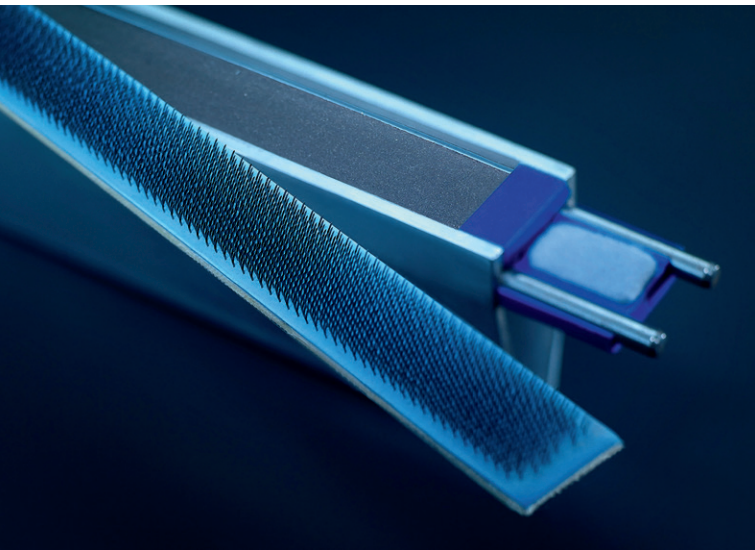

EasyTop is suitable for aluminum flat bars with magnetic adhesion technology from all manufacturers. The use of the well-known and proven Graf flat clothing is thus assured on all flat bars, irrespective of the mode of attachment. Since the introduction of the EasyTop generation of flat clothing, customers have been able to enjoy Graf quality from a single source, to suit all known types of flat cards.



Highlights

- 30% reduced downtimes during reclothing
- Cost-efficient reclothing of aluminum flat bars
- No additional service tools or service workshops required
- Fast and precise reclothing through magnetic adhesion technology ensures consistently high quality

Areas of Application

EasyTop flexible flats are especially suited for cotton, man-made and regenerated fibers.

Fast reclothing – reduced investment costs

As a result of the innovative mode of attachment by high energy magnets, the cost- and labor-intensive processes such as stripping and clipping are noticeably reduced. The flat bars can be easily reclothed without the requirement for machines or special tools by the mill's own staff in the shortest possible time. With the straightforward exchange of the flat strips, the typical flat workshop is not a necessity, resulting in considerably reduced operating and service costs. Mechanical stripping and clipping of the flat clothing can also be dispensed with.

EasyTop

Reliable magnet technology provides precision and quality

As soon as the EasyTop is placed on the flat bar, the magnetic effect will automatically assure the correct position. Due to the two adhesive and compensation layers, (see figures 2 and 3), the EasyTop technique permits the narrowest of tolerances within the entire system. Once the flat clothing is placed on the flat bar, the magnetic connection will withstand even the strongest carding forces.

The EasyTop fastening technology is totally reliable in operation. Unlike other conventional modes of attachment with clips, the EasyTop system is a non-destructive connection that can be detached with minimal effort. This makes EasyTop perfect for carrying out trials efficiently with different types of flat clothing, without loss of the existing clothing.

Customer benefits

- Time saving replacement of flexible flats without the requirement for special tools, service machines or a service workshop
- Reduction of total service costs
- Optimal carding gap due to reduced set range resulting in better IPI values and increased yarn quality
- Contribution to sustainability
- Shorter downtime of the card
- No grinding process after installation

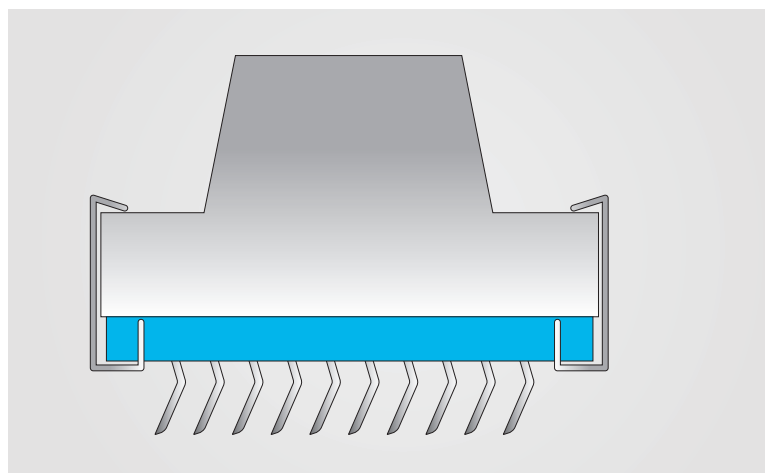

Fig. 1: Conventional attachment with clips

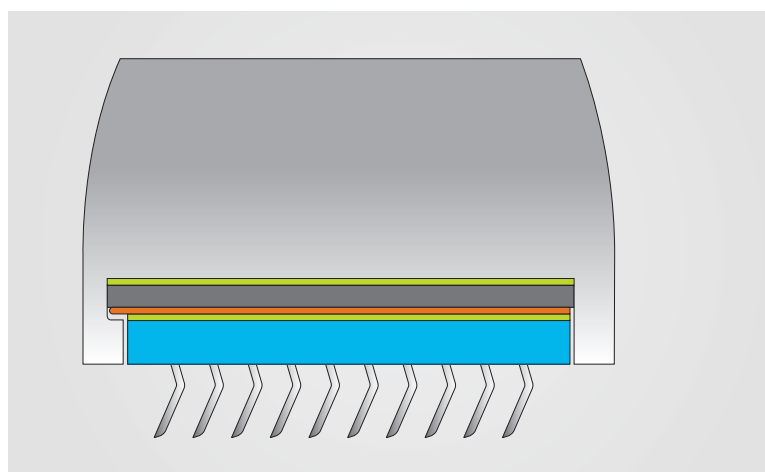

Fig. 2: EasyTop with magnetic attachment

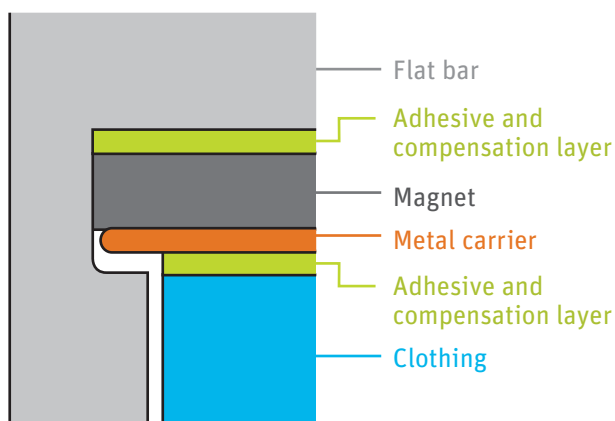

Fig. 3: Details of EasyTop

Stationary Flats

Improved opening of fibers even before they enter the pre-carding zone

Simple and smooth application
across all common systems

Exceptional quality delivered

Extended lifetime

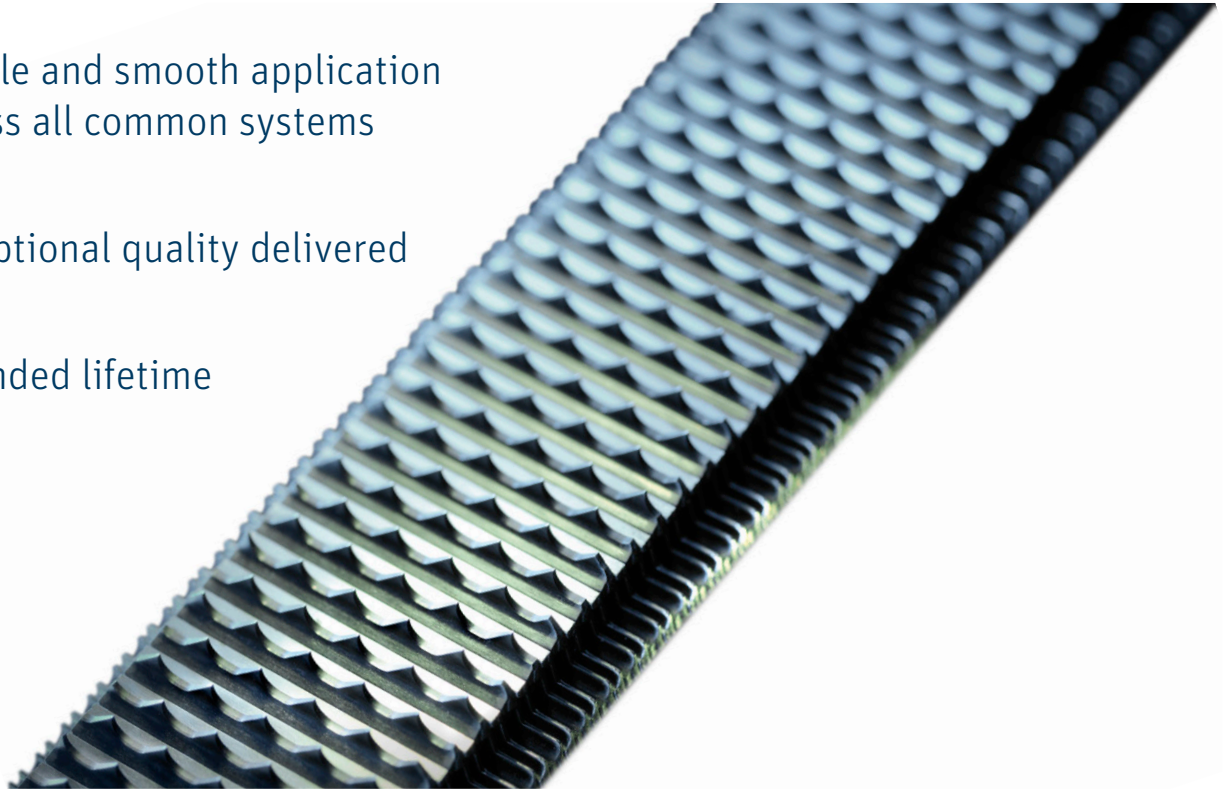

Product details

Graf stationary flat clothing ensures that fibers are processed to the highest quality and that the carding works more effectively in three zones: pre-opening; pre-carding; and post-carding.

Benefits

Graf stationary flats ensure a simple and smooth application across all known fixing systems, with exceptional quality delivered throughout the extended lifetime of each product.

Graf stationary flat clothing

The unique Swiss engineered Graf stationary flat clothing is designed to improve the opening of fibers in the pre-opening zone before they enter the carding zone, preventing unopened flakes from causing problems in the pre-carding zone. The tooth design ensures that fibers are perfectly parallelized in the post-carding zone, delivering a smooth transfer to the doffer and creating superior quality yarn, for longer.

Graf has a wide range of carding segments in the product portfolio from coarse to extra fine count yarn.

Stationary Flats

Graf's supplies stationary flat clothing for all systems in operation, e.g. Rieter TREX systems, Trützschler TT systems and others, as well as for the carding segments of blowroom equipment.

Benefits

- Long lifetime thanks to CUTTYSHARP alloy for all stationary flats
- Simple and straightforward application for all systems
- Suitable for every system

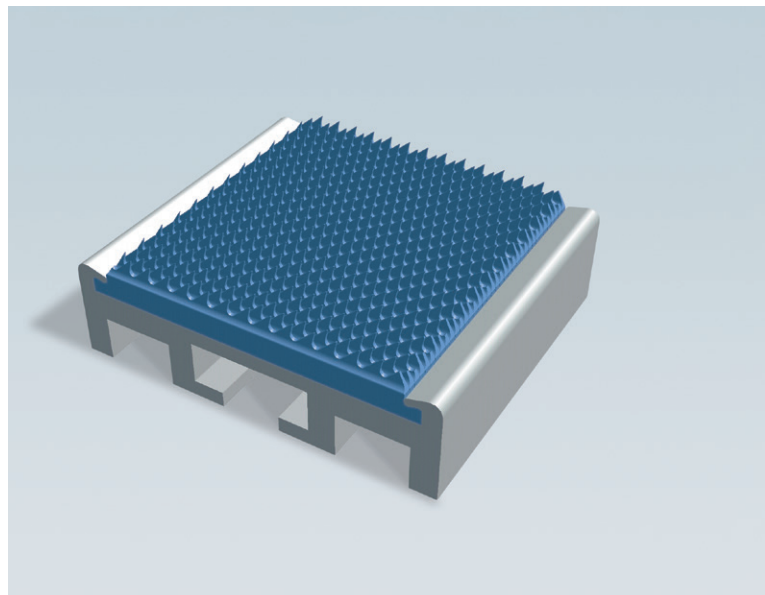

System 1 – height 11 mm

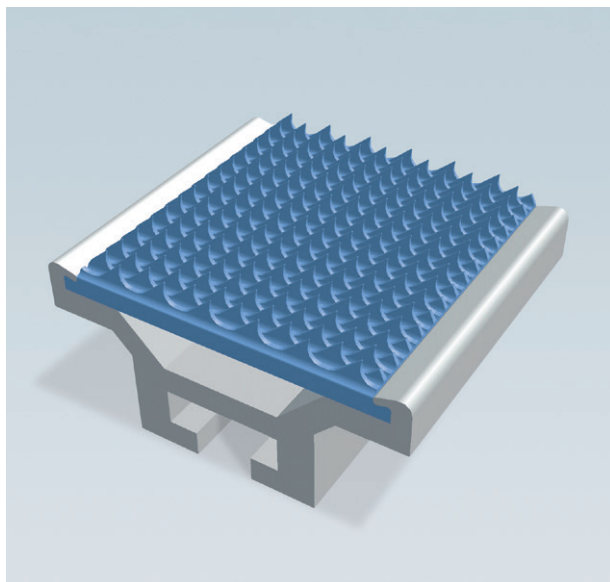

System 2 – height 16.8 mm

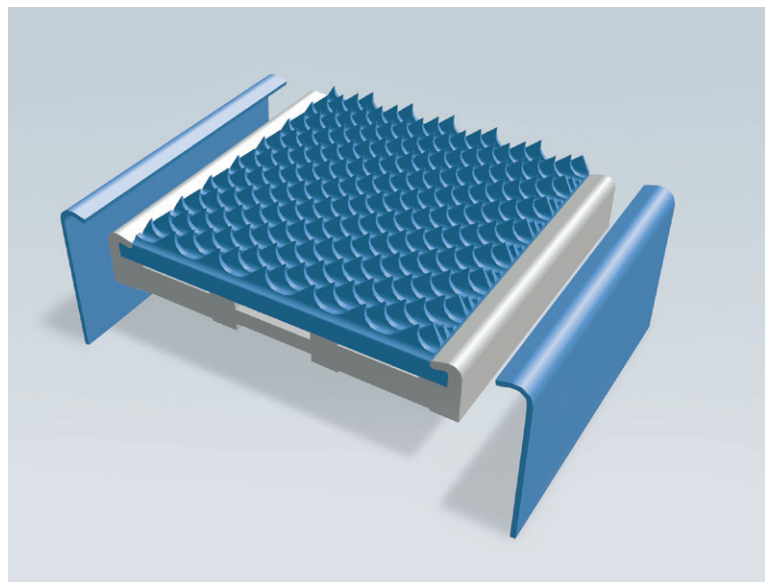

System 3 – height 7 mm

Stationary Flats

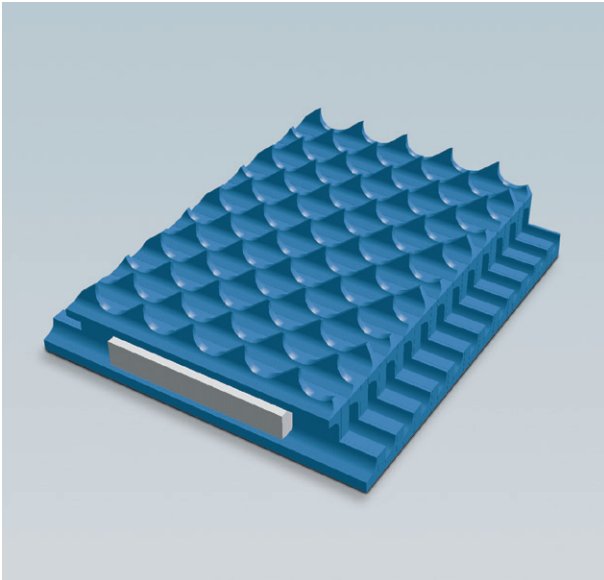

System 4 – height 7.5 mm

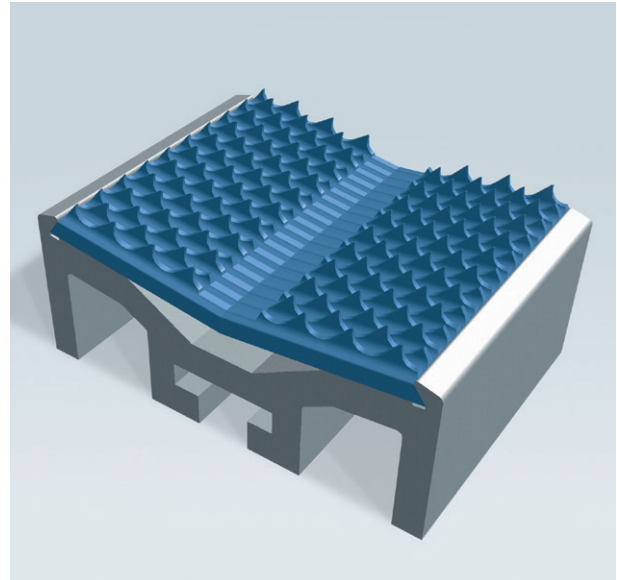

System 5 – height 18.4 mm

Stationary flat clothing for flat cards and blowroom equipment

Blow room equipment	FD 4	40 p.p.s.i.
	FD 6	60 p.p.s.i.
Pre-opening segments	FD 6 und FD 6A	60 p.p.s.i.
	FD 9 und FD 9A	90 p.p.s.i.
	FD 9B	90 p.p.s.i.
Pre-carding zone (above licker-in)	FD 9A	90 p.p.s.i.
	FD 14A	140 p.p.s.i.
	FD 14B	140 p.p.s.i.
	FD 24A	240 p.p.s.i.
	FD 24B	240 p.p.s.i.
	FD 24C	240 p.p.s.i.
	FD 32A	320 p.p.s.i.
	FD 42A	420 p.p.s.i.
FD 42B	420 p.p.s.i.	
Post-carding zone (above doffer)	FD 24A	240 p.p.s.i.
	FD 32A	320 p.p.s.i.
	FD 42A	420 p.p.s.i.
	FD 42B	420 p.p.s.i.
	FD 55A	550 p.p.s.i.
FD 64A	640 p.p.s.i.	

Cleaning and Stripping Fillets

Perfect cleaning system delivers a smoother carding process

Increased uptime

Extended lifetime with perfect
cleaning system

Enhanced quality
of carding

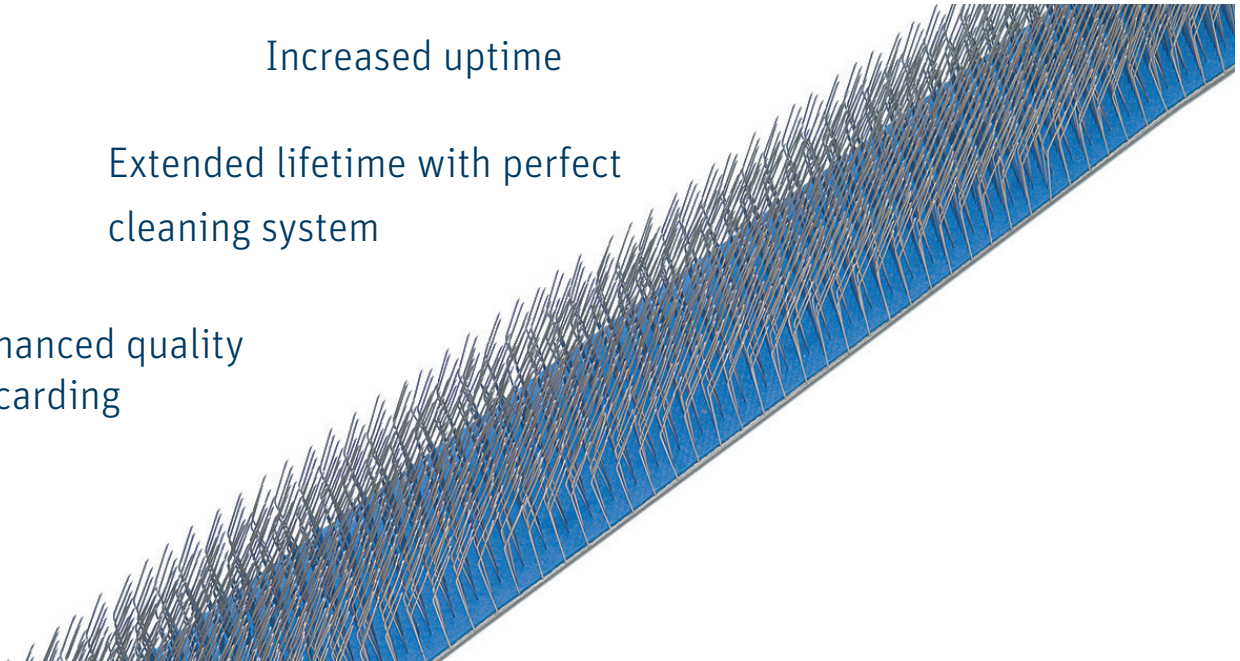

Product details

Graf offers all types of cleaning fillets for better carding. These are suitable for the cleaning of flat clothing, take-off and stripping rollers.

The Graf portfolio is suitable for all card types and includes the following products:

- Spaced flat stripping fillet, bringing optimal cleaning with less strain on the flat clothing for reduced wear
- Flat strippers, with various card-specific types for cleaning of flat clothing and flat cleaning brush
- Cleaning fillets, designed to keep the take-off roller clean and support the transfer of overflowing fibers into the suction system
- Zigzag flat stripping fillets, which require only minimal drive power and assure optimal penetration of the flat clothing

Benefits

Combined with metallic card clothing and flat clothing, correct settings and appropriate maintenance, it's the perfect cleaning system for high-quality yarn. Graf fillets ensure an extended lifetime and a better uptime of the carding machine.

Clothing for Blowroom

Wires and stationary flats – excellent raw material utilization

Highlights

- Operator-friendly adjustable settings
- Consistently high sliver quality
- Up to 20% increased machine uptime

Product details

Operator-friendly adjustable settings and intensive mixing of the fibers increase the raw material utilization. Designed for durability and resilience, they also offer an exceptionally long lifetime. Graf clothing is suitable for cotton, man-made and regenerated fibers and will work across a wide range of blowroom applications.

Blowroom wires for openers and cleaners

In blowroom machines, wires open the pressed fibers to produce fiber tufts. At the same time, trash – such as dust and seed-coat fragments – is released. Graf's exceptionally efficient metallic card clothing for openers and for feed rollers ensures a high degree of opening and cleaning of the processed fibers – thanks to the durable design. Fibers are processed efficiently and cleaned gently right from the start of the process.

With coarser or heavily soiled fibers, customers can achieve more intensive cleaning with a larger working angle. If processing fine fibers or fibers that are already particularly clean, customers can use metallic clothing with a smaller working angle.



Stationary flat clothing for pre-opening systems

Precise stationary flat clothing, also known as carding segments, provides optimized waste separation in the blowroom thanks to the unique tooth geometry. The gentle pre-carding offered by Graf stationary flats enables the fine opening of tufts and enhanced removal of trash.

The overall advantage of Graf stationary flat clothing is the simple and smooth application across all the common systems customers may be using.

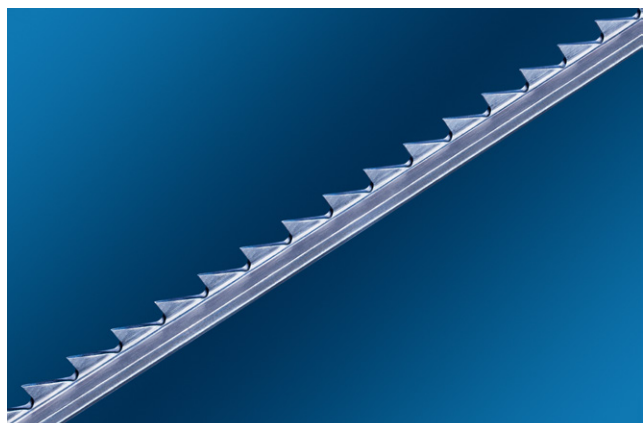

Clothing for OE Opening Rollers

Uniquely performing metallic card clothing for OE rollers for all areas of application

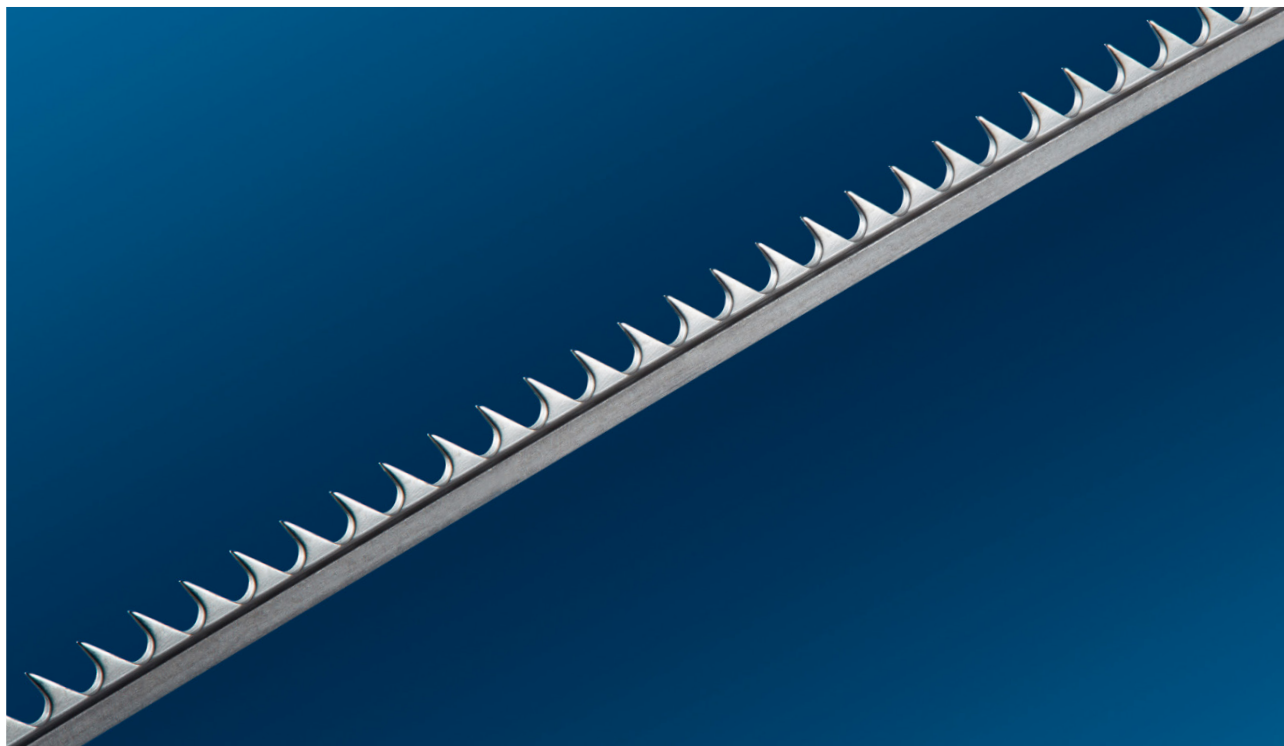

Highlights

- Gentle fiber transport
- Balanced fiber opening
- Constant yarn values

Product details

Graf metallic card clothing ensures the best quality in OE opening rollers and offers various alloys for the highest demands.

Available version

Metallic card clothing with Needle Finish surface treatment.

Benefits

- Electrochemical polishing provides improved surface quality of the metallic card clothing
- Large selection of clothing for OE opening rollers for all areas of application, raw materials, and machine types
- Metallic card clothing with different teeth densities for different materials
- Working angle up to 25°, depending on the version of the various open-end rotor spinning machines

Accessories

Improved quality ensured by precise settings

Optimal quality requires continuous settings and maintenance. This is why Graf offers all the necessary tools, from the simple setting gauge to special polishing systems and the entire set-up of flats.

Setting

Original Graf setting gauges are products of high technical precision to allow optimal carding quality. The setting gauges are designed to match the cards of various manufacturers.

Single flat gauge

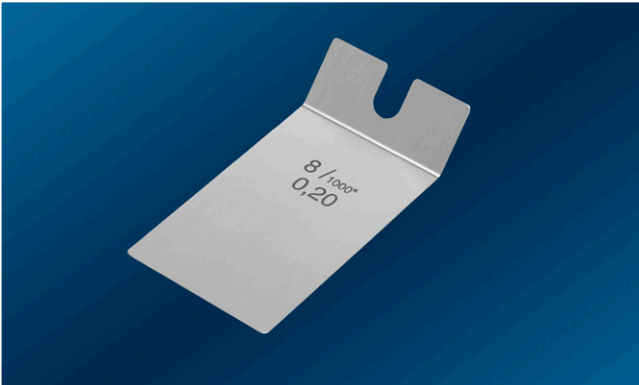

Eight-blade gauges



Polishing and cleaning

The original Graf accessories for the polishing and cleaning of clothing are well-proven high-quality products that contribute to an excellent carding quality.

Polishing sponge with holder

For the cleaning of newly mounted card clothing

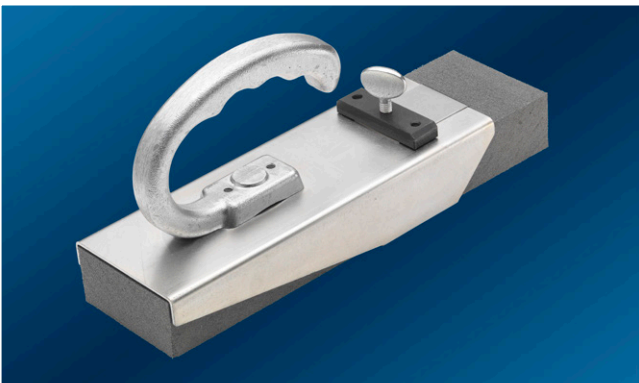

Bronze or copper wire brush (with holder)

For cleaning newly mounted or resharpened metallic card clothing



**Carborundum
Hand grinding stone with holder**

For equalizing newly mounted clothing and resharpening



Hand stripping card

Replacement clothing for hand stripping card without holder

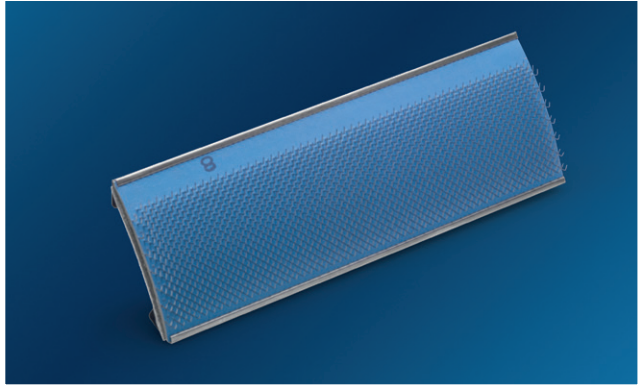

**Miraclo
Hand grinding stone with holder**

For dressing and repairing damaged clothing

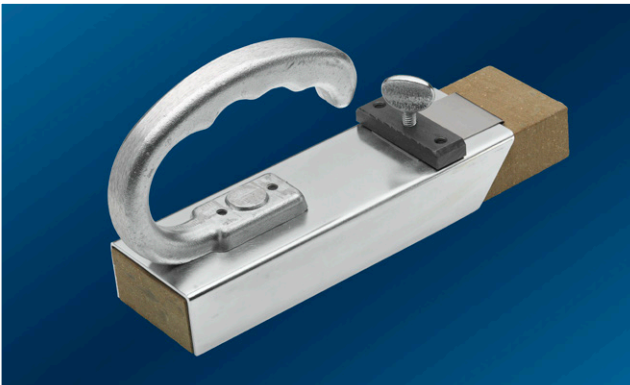

Clothing cleaner

For scraping coarse residues from clothing and for circular combs

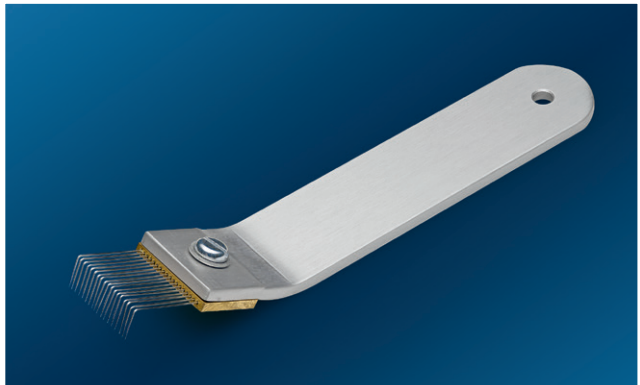

Hand stripping card with clamping device and curved or straight handle

For removing wood- and seed-coat particles from metallic card clothing and for general cleaning purposes



WiFi digital Microscope

For the precise analysis of clothing



Smart and Flexible Service Packages

Helping customers to maximize their carding investment



Highlights

- Four packages for all card clothing applications
- Option for customers to manage inhouse or use Graf experts
- 40 service stations worldwide

Clothing service extends lifetimes many times over

Flexible flat clothing produced with the highest precision has a much bigger impact on the carding quality than cylinder clothing. The number of neps in the card sliver is mainly influenced by the state of the card clothing. Regular servicing of the clothing not only maintains a more consistent number of neps, but also pays off economically.

Ultimate flexibility

Graf offers a high standard of Swiss engineered service machines. This enables customers to decide whether they want to carry out the service themselves or have the service carried out by Graf experts, while they concentrate on their core business. Four solution packages cover a wide range of applications, with the aim of extending card component lifetime and therefore reducing machine downtimes to a minimum.

Service package solutions

1 Designed for re-winding and grinding/activation of card clothing

This package resharps all card clothing and readjusts each tooth back into nearly original condition, which leads to a longer product lifetime.

Requirements	Purpose of machine
GAV	Metallic wire mounting *)
TSG 40 – 60" pneumatic	Traversing grinding device
ASG	Doffer grinding device
ROD 35, ROD 35/1 **)	Roller mounting rack

*) incl. DABW, butt welder **) incl. UAV25

2 Equalizing and grinding of flats on card

Flat equalizing after 15 t and consistent grinding over the product lifetime, which leads to an optimal carding gap and sharp tooth tips.

Requirements	Purpose of machine
DSW 40 – 60"	Flat grinding roller
DEW 40 – 60"	Flat grinding roller

3 Flat service in workshop with end shoe milling and clipping of flat bars

Flat maintenance for a constant and perfect in-shape and newly clipped flat sets, ensuring consistent quality.

Requirements	Purpose of machine
DAM 35/1	Flat clipping machine
DSM 20/1	Flat grinding machine
DKF 10	Flat end milling machine
ESM 150	Easy shoe milling machine

4 For startup, provides all services needed to put flat card back into operation

Smooth card restart and optimum conditions to achieve the desired quality.

Requirements	Purpose of machine
Service technician	Final setting and restart

Global service footprint – Graf supports customers worldwide





Graf + Cie AG

Bildastrasse 6

8640 Rapperswil

Switzerland

Phone +41 55 221 71 11

Fax +41 55 221 72 33

info@graf-companies.com

www.graf-companies.com

The data and illustrations in this brochure and on the corresponding data carrier refer to the date of printing. Graf reserves the right to make any necessary changes at any time and without special notice. Graf systems and Graf innovations are protected by patents.

3551-v1 en 2305 • Art. No.: 88001307