

Ring spinning  
Ring spinning machine G 38

**RIETER**



**G 38**

Ring spinning machine G 38



High-quality yarns produced  
with high flexibility and speed



# G38

Full Flexibility  
for Producing  
Standard, Compact  
and Special Yarns

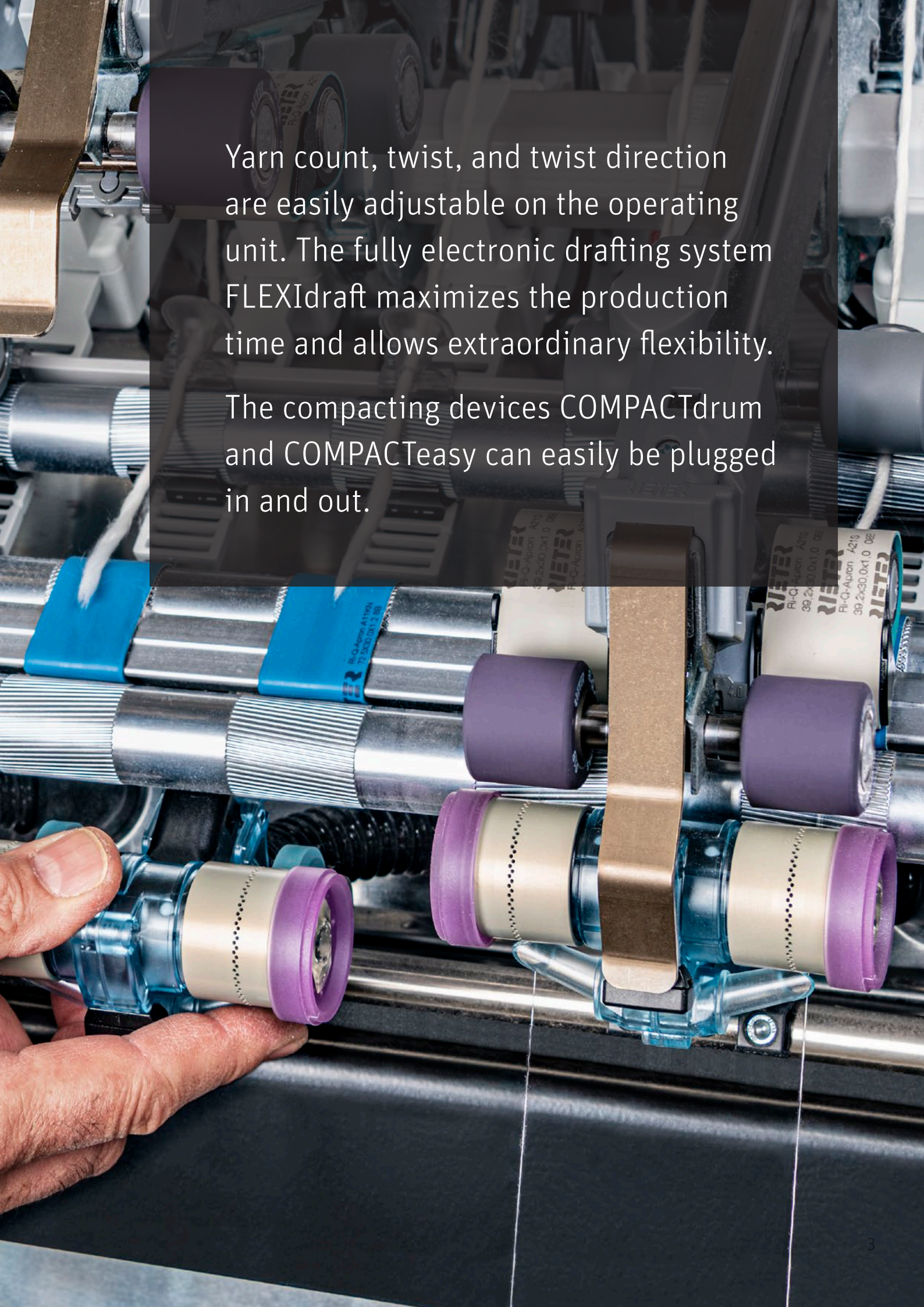

Yarn count, twist, and twist direction are easily adjustable on the operating unit. The fully electronic drafting system FLEXIdraft maximizes the production time and allows extraordinary flexibility.

The compacting devices COMPACTdrum and COMPACTeasy can easily be plugged in and out.

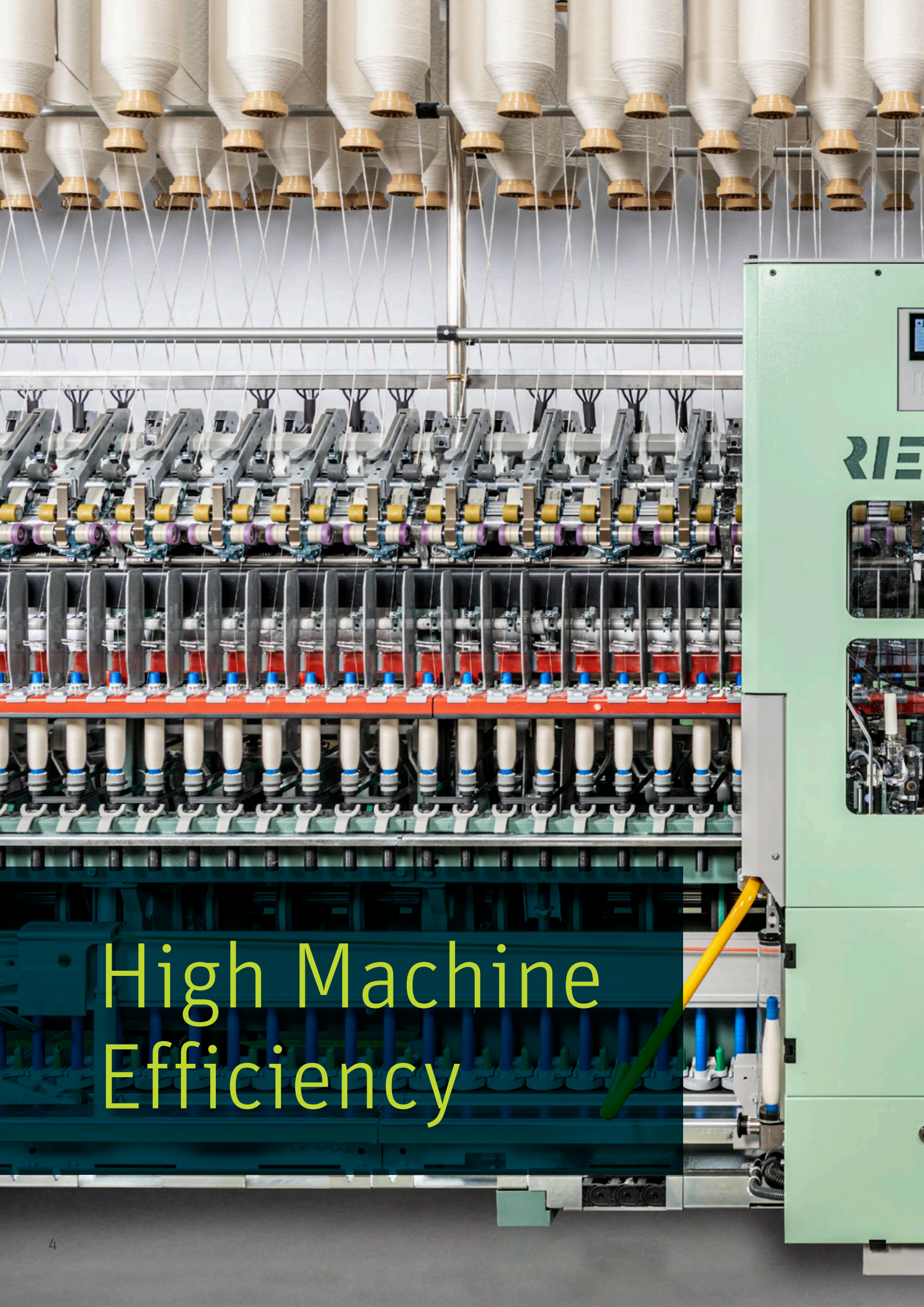

# High Machine Efficiency

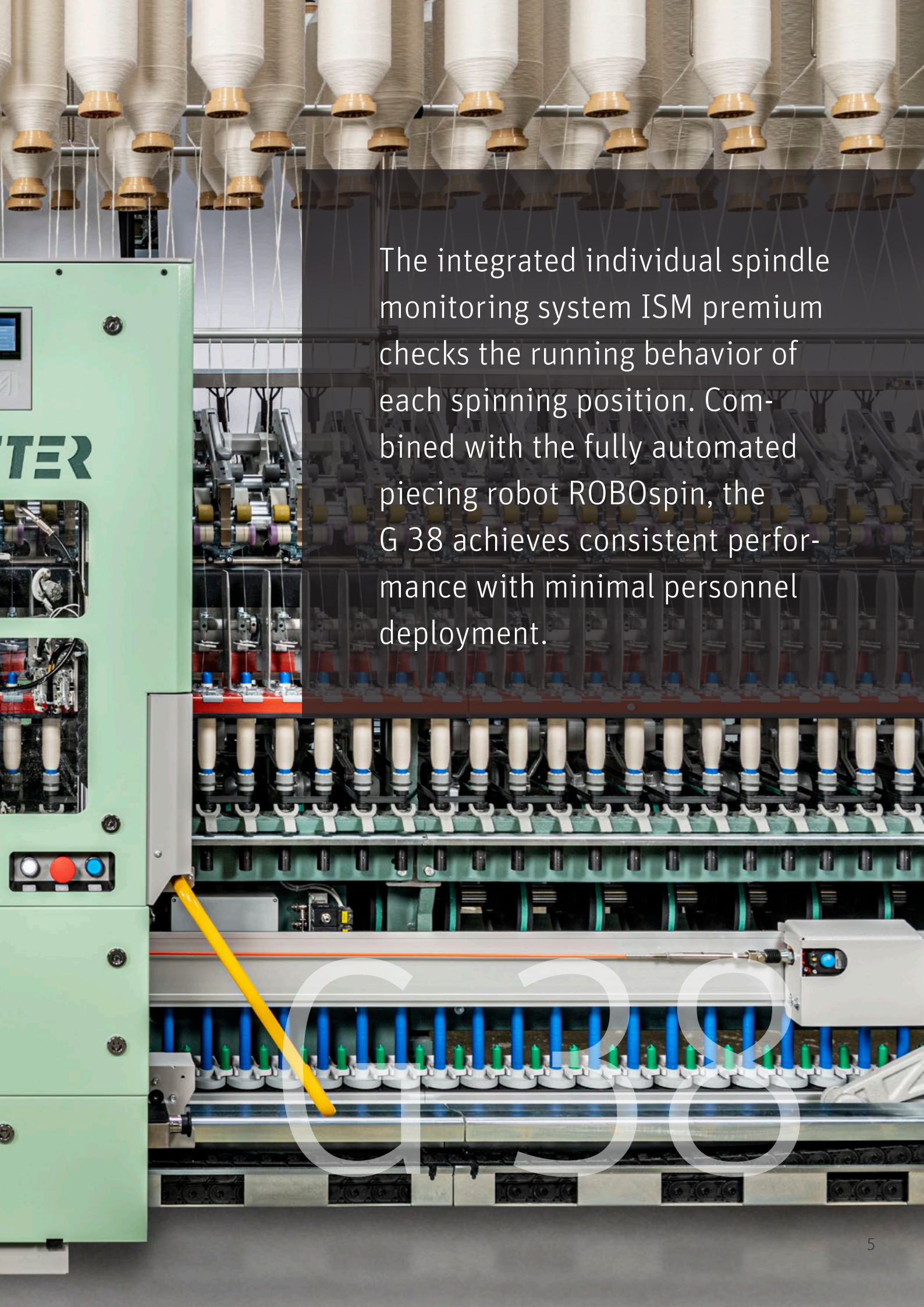

The integrated individual spindle monitoring system ISM premium checks the running behavior of each spinning position. Combined with the fully automated piecing robot ROBOspin, the G 38 achieves consistent performance with minimal personnel deployment.

G38



With spindle speeds of up to 28 000 rpm, production is increased by 12%. With the High-Speed Package (34 mm spinning ring, 16 mm DUI tube/spindle dimension, LENA 28 spindle) the production limits have been considerably extended.



# Highest Spinning Speeds

G38

## Consistent Performance

Fully automated piecing robot ROBOspin for minimal personnel deployment

## Concept for Low Energy Spinning

Energy-savings with efficient suction system, IE4 motors, LENA spindles and 4-spindle drive

## Highest Spinning Speed with High-Speed Package

34 mm rings, DUI 16 tubes and LENA 28 spindles push the limits

## Maximum Flexibility with Innovative Compacting Solutions

COMPACTdrum and COMPACTeasy for fast switch between ring and compact yarn

## High Efficiency with ISM

Integrated individual spindle monitoring ISM premium for efficient operator guidance

## Economical Doffing Ensures Maximum Efficiency

Unique and self-monitoring SERVOfrip makes yarn underwinding redundant

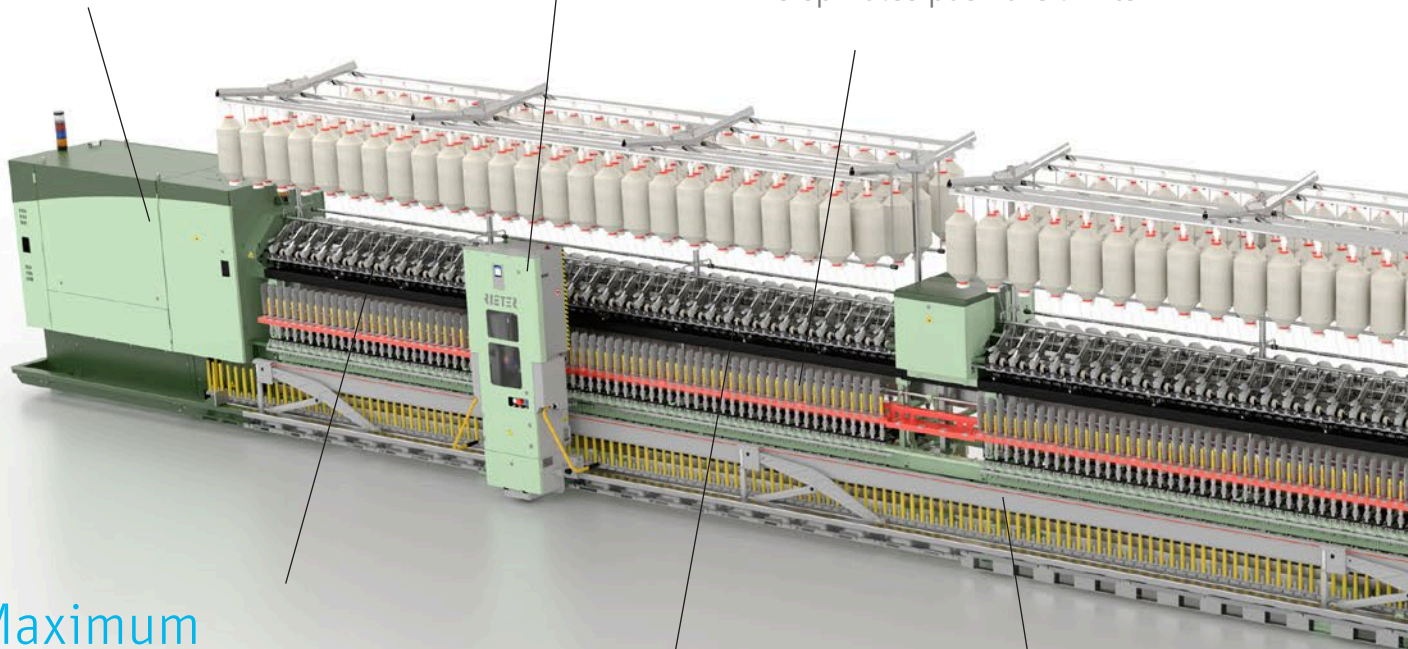



# G 38

## OUTSTANDING ADVANTAGES

### Fast Change of Yarn Parameters

Fully electronic drafting system  
FLEXIdraft for easy change of  
parameters on the operating unit

### Intelligent Linking with Winding Machine

Automation solutions Multilink/  
Multilot or ROBOLoad with WILDload  
for efficient tube handling

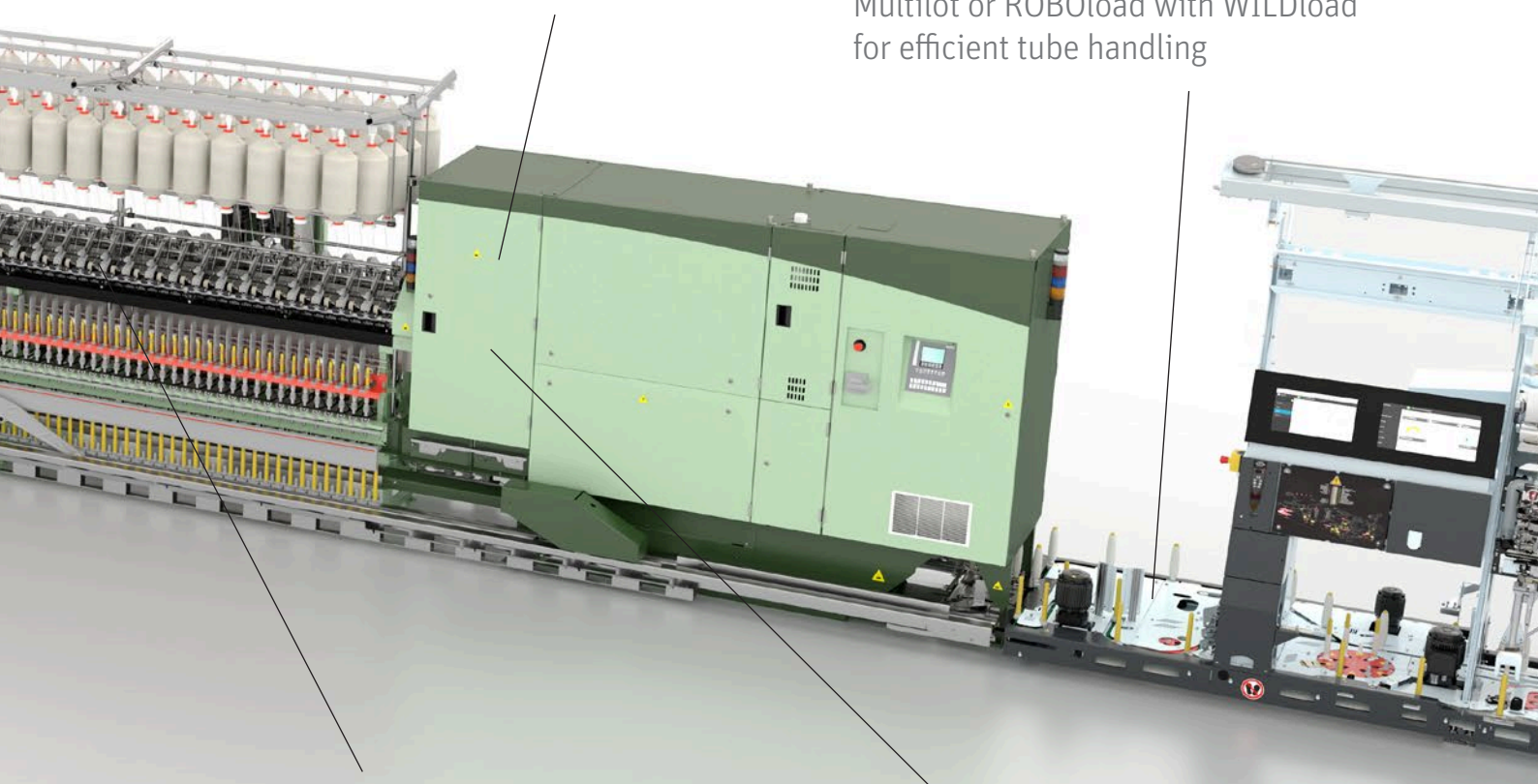

### Ring Yarns of Highest Perfection from Any Fiber

Special components available for recycled raw material and man-made fibers

### Full Flexibility for Special Yarns

Systems for core, slub (VARIOspin) and twin yarns are available for all machine lengths

# Fully Automated Piecing Robot ROBOspin

**ROBOspin is the first fully automated piecing robot for ring spinning machines. One robot per machine side repairs ends down that occur during startup or while the machine is running.**

## The industry's first fully automated piecing robot in ring spinning

The robot travels directly to the affected spinning position and repairs the ends down in the shortest time possible. As a result, the complete piecing cycle runs fully automatically – from finding the yarn on the cop to threading the traveler and placing the yarn behind the delivery roller. The robot receives the required information from the integrated individual spindle monitoring system ISM.

## Consistent quality, 24/7

The automated piecing process ensures consistent quality of the yarn piecing. Human contact with the cop is avoided during the cycle. The outer layer does not get contaminated and top quality yarn is produced.

## Maximum productivity with minimal personnel deployment

ROBOspin has a consistently high productivity level – 24 hours a day. It reduces personnel requirements in the ring spinning section by 50%, noticeably lowers personnel costs and helps overcome labor shortages. Human resource planning and spinning mill organization are made easier.

## Consistent high performance proven in spinning mills

ROBOspin runs with consistent high performance in various spinning mills around the world. The piecer efficiency reaches over 80% in the first attempt. In the second attempt an auxiliary yarn is used which achieves additional 10% efficiency. Piecing with auxiliary yarn helps to protect the sensitive yarn layers and thus improves quality.

### The robot reliably reaches up to 95% piecing efficiency

Ne 30, 100% cotton carded, G 37 with ISM premium, 18 000 rpm, 1 824 spi/machine

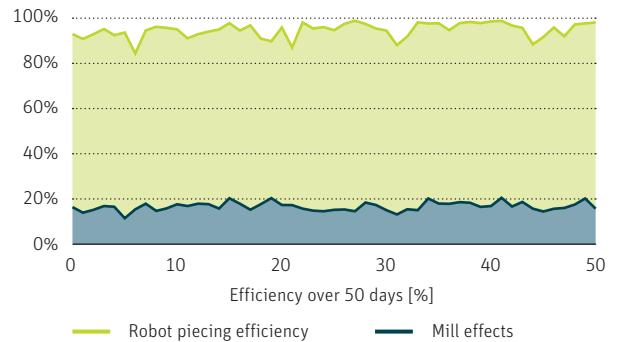



# Highest Spinning Speeds

The further development of the proven ring spinning machine G 38 with the High-Speed Package and the usage of the compacting device COMPACTdrum, bring enormous customer benefits in terms of productivity and energy savings.

## 12% higher production

The production output of a ring spinning machine is directly related to the level of the spindle speed. With a spindle speed of increase from 25 000 rpm to 28 000 rpm and delivery speeds of up to 40 m/min, the G 38 produces 12% more yarn at the same time. Developments in the spindle design of Rieter spindles coupled with optimizations in drive technology and new spinning ring combinations enable highest productions values in practice.

12% higher spindle speed maximum [rpm]

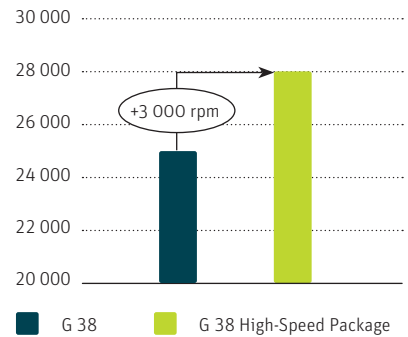

## Pushing the limits with the High-Speed Package

The performance of the G 38 is remarkable with the energy-saving LENA spindles and the new ring/tube dimensions. A ring diameter of 34 mm which perfectly fits to the small LENA 28 spindle, enables highest spindle speeds. The traveler needs less time for one revolution on the smaller ring. The traveler speed is reduced with a smaller ring diameter and frees up potential for an increase in spindle speed.

The smaller the ring diameter, the more doffing operations are needed. This fact could be decisively improved with the adaptation of the spindles and spinning tubes with the smaller DUI dimension of 16 mm. The reduced, lower inner diameter of the tube (DUI) allows a larger package or more yarn weight to be accommodated. As a result, the number of doffing operations at the ring spinning machine but also the number of cop changes on the winding machine don't increase.

12% higher production: CO, Ne 60 [tons/year/mc]

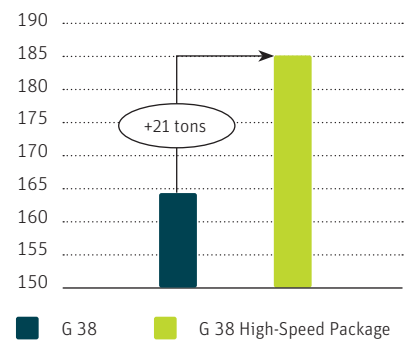

10% higher cop content: DUI 16, 34 mm ring [%]

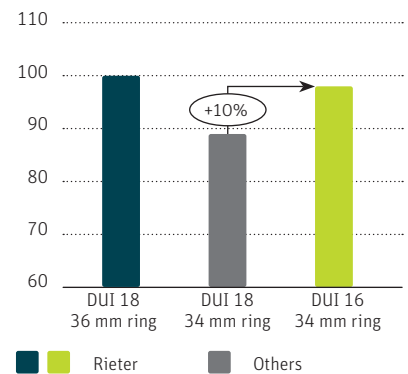

## Spindle LENA 28 for high speed and low energy consumption

The selection of the optimum spindle is a key factor for high productivity with consistently uniform yarn quality. With the latest development in spindle construction, the production limits have been considerably extended. With the new HPS 28 and LENA 28 spindles, revolutions of up to 28 000 rpm can be run. Both spindles have a second damping system to remarkably reduce the bearing load and the noise level. Low vibration, low maintenance and a long service life are the distinguishing features of these spindles.

Compared to conventional spindles with a whorl diameter of 18.5 mm or 25 mm, the LENA spindle with 17.5 mm brings significant advantages for finer yarn counts. LENA has a neck bearing of 5.8 mm and a foot bearing of 3 mm. These bearing dimensions together with the whorl diameter of 17.5 mm, make LENA 28 fast and highly energy efficient.

The high-precision LENA 28 spindle is available in two DUI dimensions (DUI 18 and DUI 16) and achieves the highest production values in practice. LENA stands for Low Energy Noise Absorption.

Energy consumption comparison

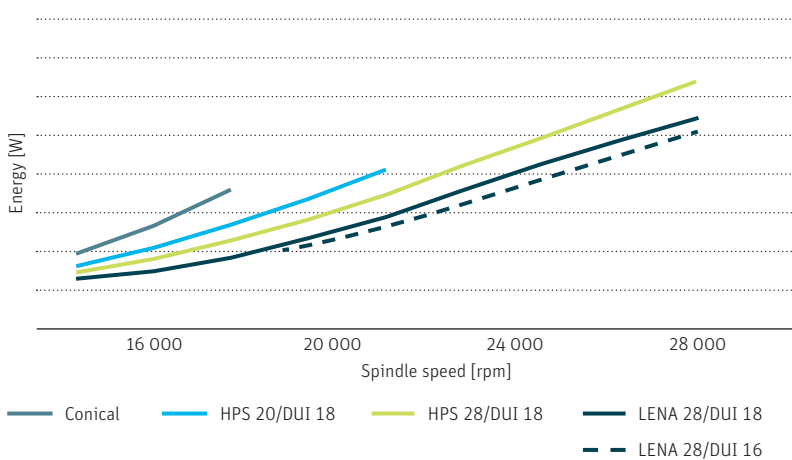

LENA 28, HPS 28 and HPS 20 are compatible with new Rieter ring and compact-spinning machines.

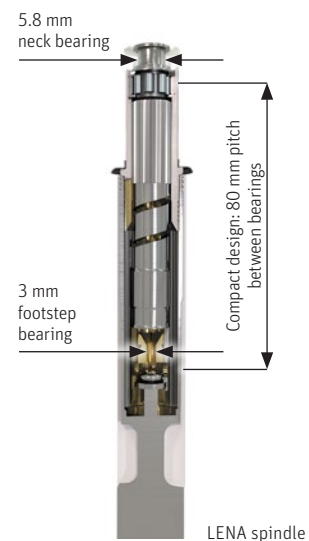

## Faster to maximum spindle speed

Highest productivity levels and minimal energy consumption lead to low yarn production costs. With its unique Rieter spinning geometry and the consistent use of high-quality technology components, the G 38 runs at very high spindle speeds. Spinning can be performed at high speed, even when the cops are in the build-up phase. With a yarn count of Ne 30, for example, up to 2% more yarn can be produced per machine per year.

Up to 2% higher productivity using the same maximal spindle speed

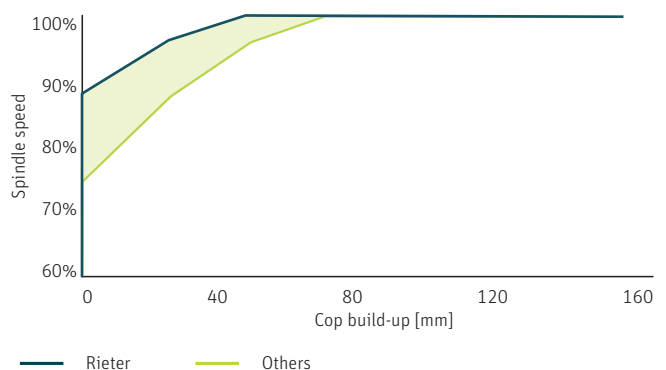

# Electronic Drafting System for Fast Yarn Changes

## Electronical setting of yarn parameters

The advanced electronic drafting system drive FLEXIdraft for the ring spinning machine G 38 uses frequency-controlled motors. This electronic drafting system drive means less work for operating personnel. Parameters such as yarn count and yarn twist can easily be adjusted on the operating unit. There is no need to change gear wheels or make any other mechanical adjustments. The operator can also change the Z-twist direction or the S-twist direction of the yarn on the operating unit.

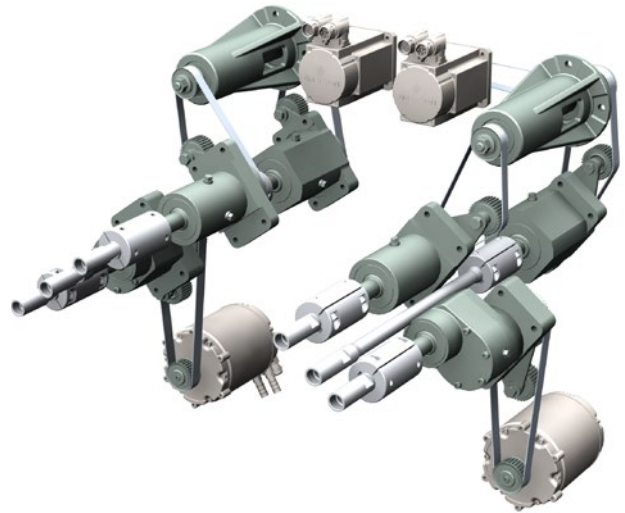

Drafting system drive FLEXIdraft with frequency-controlled motors

## Economic startup

The optional FLEXIstart allows the drafting system to be switched on and off in stages. This allows for a more efficient machine startup. Depending on the machine length, only a quarter or half of the machine is commissioned. This avoids unnecessary material waste.

Full control during a power failure reduces production loss

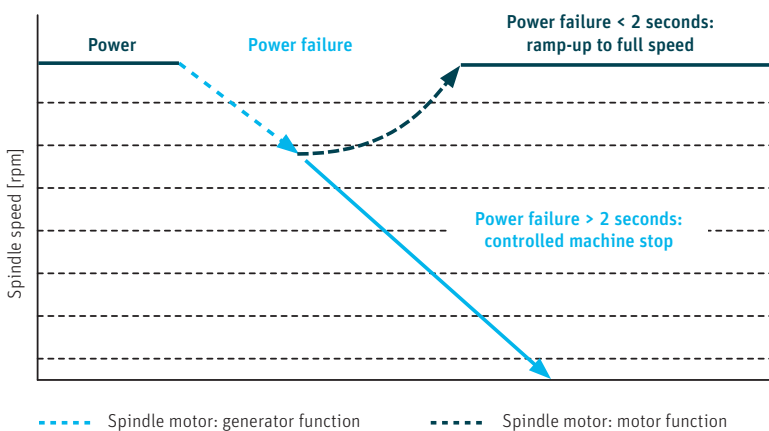

## No ends down in the event of a power failure

If a power failure occurs, the rotational energy of the spindles is used to supply the machine control systems with electricity. At this time, the main motor switches to generator mode. The machine comes to a controlled stop in the event of extended interruptions, thus avoiding ends down.

# Full Flexibility for the Production of Standard and Special Yarns

## Efficient production of slub yarns

The ring spinning machine G 38 is an all-rounder that allows the business to respond quickly to changing market requirements. Optionally, the machine can be equipped with the slub yarn system VARIOspin. The late generation servo motors are ideal for the high dynamics involved in slub yarn production.

A range of slub designs can easily be programmed on the operating unit or an external computer with the appropriate software. This allows slub yarns to be produced efficiently and profitably with outstanding Rieter quality.

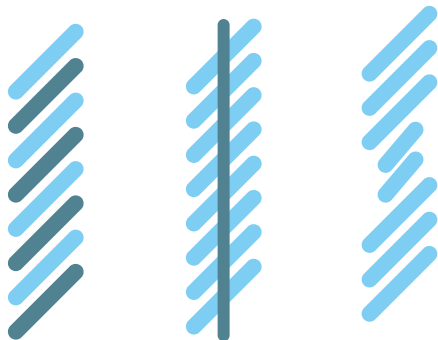

Twin, core and fancy yarn

## Q-Package – the quality package for cotton

The quality package Q-Package for cotton contains a nose bar, an “active” cradle (moving deflection edge), and a pressure bar (pin). Fiber guidance between the cradle and the nipping point of the delivery roller is further improved with the Q-Package. The evenness of the yarn (CVm%) is improved by up to one percentage point. At the same time, yarn imperfections are reduced by 10% to 30%.

## Precise production of core yarns

With the core yarn devices, soft, hard, and dual core yarns can be produced. The filament is always precisely integrated into the yarn. The core yarn devices work with a traversing guide roll for the filament. The traversing system for the filament is aligned with the traversing system of the roving.

## Easy production of twin yarns

To produce a twin yarn, two rovings must run to one spinning position. In the drafting system, both are drafted separately. The rovings are then twisted together in the spinning triangle. Due to their ply-yarn-like characteristics, twin yarns improve the quality of the yarn and the end product.

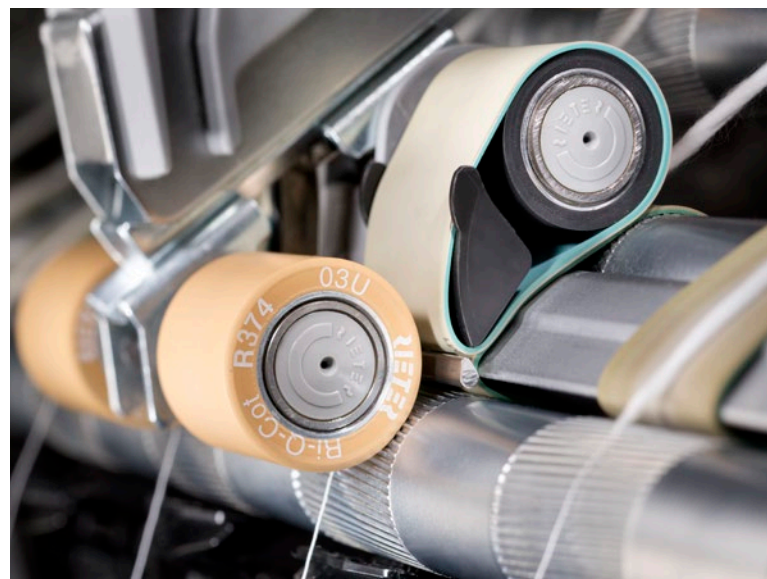

# Compacting Devices: Easy Change between Ring and Compact Yarn

The G 38 opens up attractive possibilities in compact spinning. The compacting devices COMPACTdrum and COMPACTeasy are simple to install and remove. This enables switching between ring and compact yarn. The yarns fulfill a range of different customer requirements – very high yarn tenacity and reduction in hairiness.

## COMPACTeasy – the mechanical compacting solution

The compacting device COMPACTeasy is attracting customers thanks to its low investment costs. COMPACTeasy produces yarns with excellent characteristics from all standard raw materials. This is based on the intensive double compacting that does not require any additional energy.

### Compactor with y-channel

COMPACTeasy is a mechanical compacting system, permitting real compacting without additional energy consumption owing to the y-channel in the compactor. COMPACTeasy is particularly suitable for the most common applications, including the spinning of blends and 100% man-made fibers. It is the ideal solution for customers using the fast plug in and out function to switch easily between compact spinning and conventional ring spinning.

### Traverse motion

Part of COMPACTeasy is the support of the traverse motion. The COMPACTeasy compactor is directly connected to the standard traverse rod of the ring spinning machine. This allows a traversing of 6 mm. This is a considerable advantage over the flipping of the front top roller which is usual in mechanical systems. It extends the service life of cots and ensures in particular a permanently constant yarn quality.

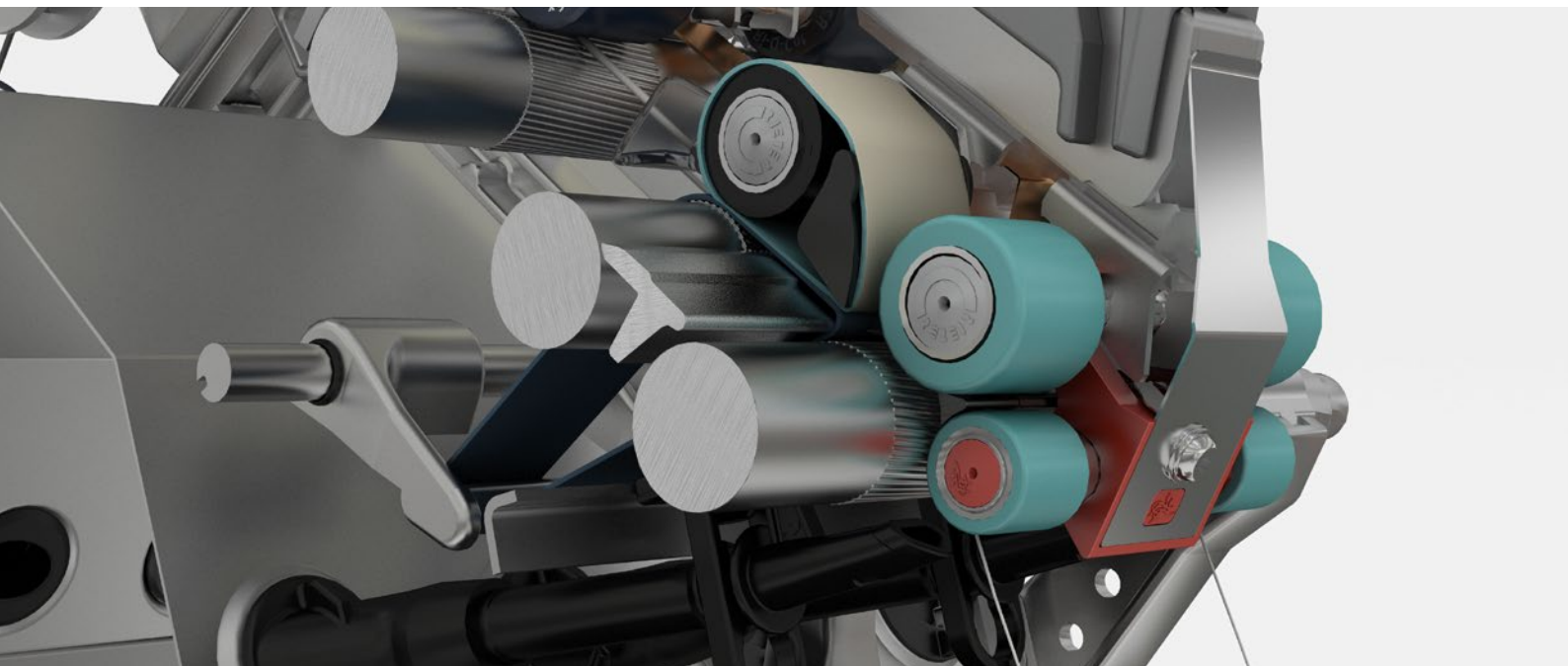



## COMPACTdrum – Minimal hairiness and maximum flexibility

COMPACTdrum produces yarns with optimal characteristics that take yarn hairiness reduction to a whole new level: Long protruding fibers are reduced to an absolute minimum. The compact yarn is highly sought-after in downstream processing.

The long-lasting technology components used in the COMPACTdrum system ensure that the yarn quality stays consistently high in the long term, regardless of which raw material is used. In addition, COMPACTdrum features a detect function which constantly monitors the compacting process. This ensures consistently fully compacted yarn and reduces personnel requirements.

### Profitable compacting

Due to the low-maintenance drum, the compacting technology COMPACTdrum enables compact yarns to be spun with very low production costs. This is primarily due to its low energy consumption – even at maximum productivity.

The sieve drum system is extremely low-maintenance as it is fitted with components that have a long service life. This ensures that maintenance costs are kept to a minimum.

### Exceptionally flexible

The compacting device is easy to plug in and out. Conventional ring yarns and compact yarns can be spun on the same machine. This offers a high level of flexibility when faced with market requirements that are constantly changing. The compacting device can be customized to suit any Rieter ring spinning machine, processes almost every type of fiber and can be easily and quickly adjusted to the raw material.

New Rieter ring spinning machines can be delivered with COMPACTdrum. Almost every existing Rieter machine can be upgraded with minimal installation efforts.



# Energy-Efficient

## 4-spindle tape drive and LENA spindle

The Rieter 4-spindle tape drive is energy-efficient and easy to handle. The large enlacement of 90° ensures that the spindle operates without failure, even with minimal contact pressure. The low contact pressure guarantees low energy consumption.

The new LENA 28 spindle has been specially developed for high spindle speeds and low energy consumption. This saves additionally up to 6% energy. The whorl diameter of 17.5 mm and other optimizations make a significant impact on energy efficiency.

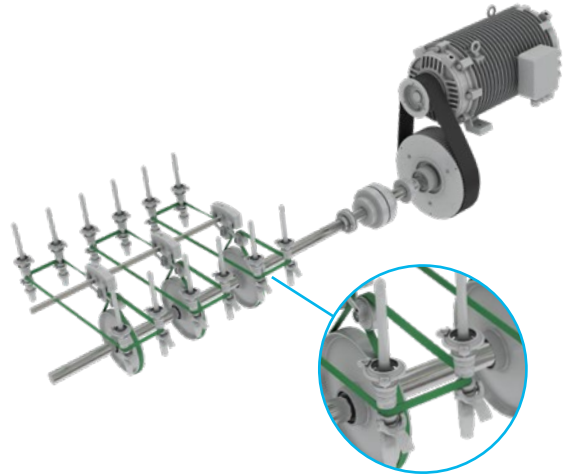

Efficiency depends on technology and motor size

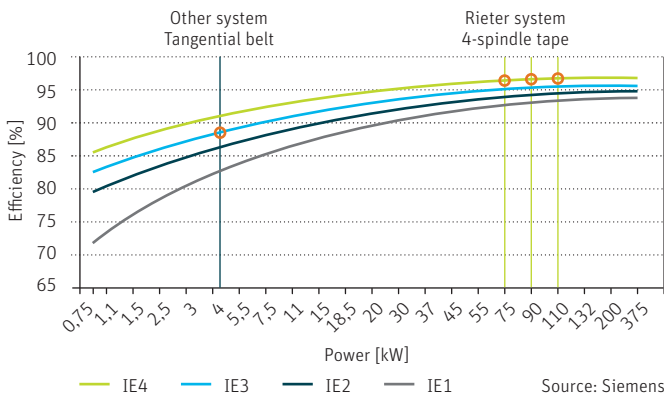

## Efficient IE4 main motor drive

The extremely efficient IE4 main motor drives were developed for high speeds to save energy. It can also be used profitably on machines with fewer spindles and low speeds due to its permanent magnetic functioning.

Efficiency is not only related to motor technology but also to motor size. With one single spindle motor and the choice of IE4 motors, Rieter invests in sustainable yarn production.

## Less energy required with double-sided suction

The double-sided suction optimizes the aerodynamics of the entire suction system. This reduces the energy that is required to generate the necessary underpressure on machines with up to 1 824 spindles. Compared to single-sided suction system, the same air volume can be transported using less energy. The large duct cross-section and low air speed reduce the air friction. This results in additional energy savings.

Energy saving potential with double-sided suction

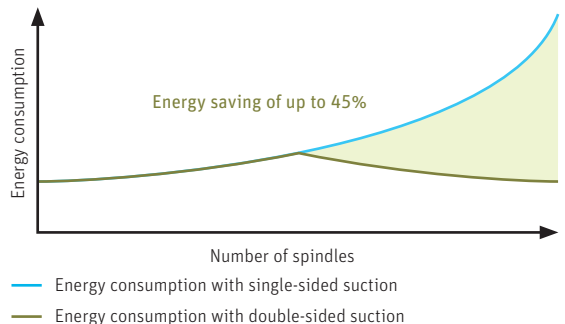

## Economical Doffing Ensures High Efficiency

### Save yarn with the SERVOflex system

The proven and unique Rieter SERVOflex system enables doffing without underwinding. By using SERVOflex, no yarn ends need to be removed from the whorl. This saves yarn and keeps the machine clean. Ends down caused by fiber fly and yarn ends are also avoided, thus increasing yarn quality.

The SERVOflex system contains a clamping crown. Rieter is the only manufacturer whose clamping crown is opened and closed using the ring rail. This guarantees precise and controlled fixing of the yarn. Ends down following cops changes are thus largely avoided.



### Self-monitoring grippers

The doffing system is self-monitoring, including the special profile of the doffer beam and the releasable grippers. The newly designed gripper has a safety clip for a more precise and reliable tube positioning. The long lasting gripper membrane with improved grip is abrasion resistant and easy to replace. In the event of faults, the doffing process is automatically stopped by a pressure monitor, ensuring highest process safety.



### Reliable and economical cops transport system SERVOflex

The cops transport system SERVOflex is an open system that requires less maintenance. The system is driven by two diagonally offset 70 W motors. This requires only 10% of the energy compared to those of a pneumatic system. Intelligent cop trays (Smarttray) with integrated RFID chip are available with link system to the Rieter winder Autoconer X6.



# Ring Yarns of Highest Perfection from Any Fiber

## Ideal fiber guidance in the drafting system

The drafting system Ri-Q-Draft ensures the ideal fiber guidance for most applications and very stable running behavior. The deflection bridge Ri-Q-Bridge is a key component in the spinning process. The optimal position and form of the cradle reduce the distance to the nipping point of the delivery roller. All listed technology components, including the bottom aprons, are perfectly tailored to each other. This ensures ideal fiber guidance in the main draft zone.

## Premium components as standard

The top roller cots Ri-Q-Cot developed by Rieter ensure perfect yarn quality. Different cots are available depending on the processed raw material and the yarn count.

High-quality TITAN spinning rings from Bräcker are included in the G 38 standard package. These spinning rings have a long service life.

All machines are delivered exclusively with proven Novibra quality spindles, which have excellent running characteristics. Energy consumption and noise levels are lower compared to those of other products. Higher spindle speeds can be achieved as the Novibra spindles reduce vibrations to a minimum when running.

Rieter's precise quality spinning tube Ri-Q-Tube is made from a particularly stable polymer mixture and has a high true-running accuracy. The spindle bearings experience minimal load even at high speeds.

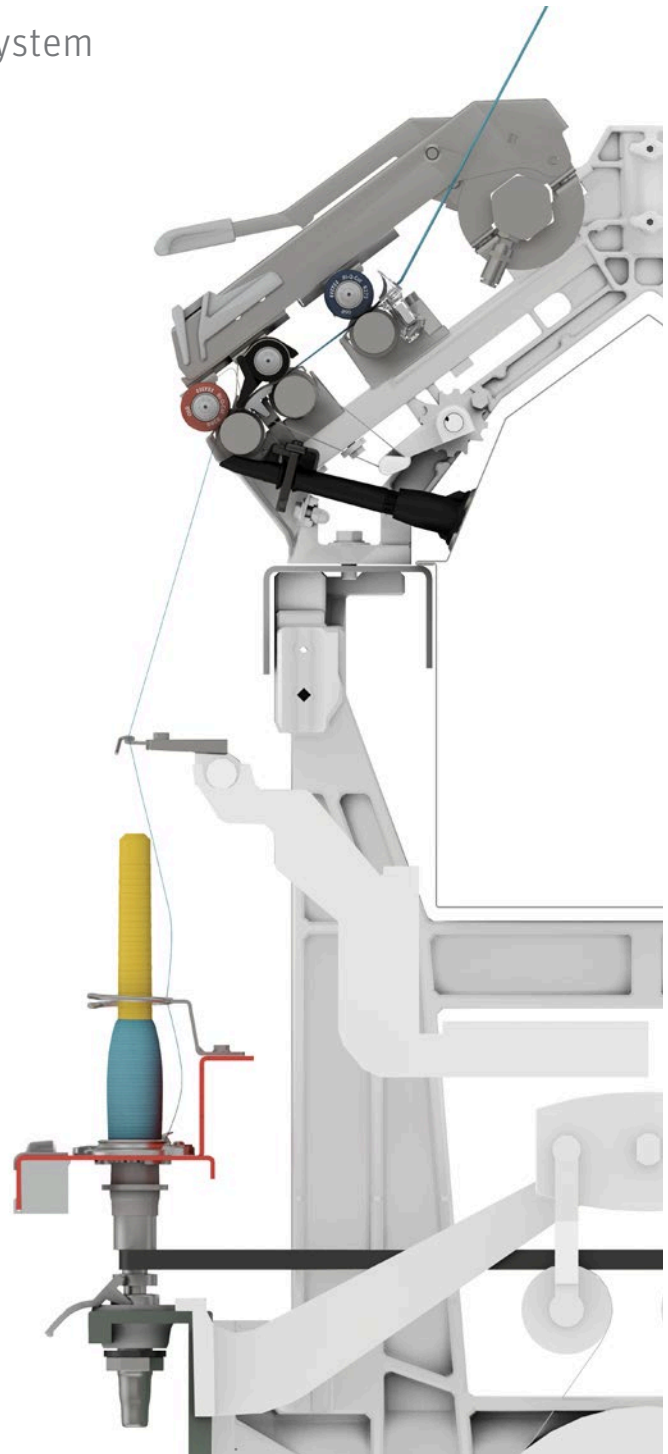

## Special components for recycled raw material, man-made fibers and blends



Rieter offers a full package of components especially for man-made fibers like SERVOfrip knife, bottom rollers with a larger diameter, and reinforced separators. It is a modular set. The individual elements can be configured based on customer requirements. The man-made fiber package improves spinning performance for yarns made of man-made fibers and blends.

The bottom rollers have a larger diameter and improve the running characteristics of the machine when long man-made fibers are used.

The metal-reinforced front edge of the separators prevents notching from rotating thread ends. No fibers get caught. The run of the thread is not interrupted by flying fibers; as such, the ends down rate is very low.

## Reliable yarn cutting for man-made fiber yarns with the SERVOfrip knife

The SERVOfrip knife reliably cuts the yarn during doffing and prevents ends down during startup. Rieter has developed a technology that reduces yarn twisting before doffing. When combined with the SERVOfrip knife, even high-strength yarns or core yarns can be cut properly when doffing.

## Ring yarns with up to 40% recycled cotton

The production of ring yarn with acceptable quality from heterogeneous, recycled raw materials with a high short-fiber content brings new challenges. Thus, ring yarns made of recycled cotton can rarely be found on the market up to now. Rieter sets new standards and offers a complete ring spinning system that is designed to process recycled fibers in the best possible way. High-quality ring yarns with a share of 38% recycled cotton are possible. Due to the better integration of the fibers during ring spinning, ring yarn has a higher tenacity. This opens a wider range of applications for yarns made of recycled cotton.



# High Machine Efficiency Through Digitization

## Efficient production with ISM premium

The individual spindle monitoring system ISM premium is built into the machine as a standard. In addition to LEDs at each spinning position, it also has an LED at each section and signal lamps at the head and end of the machine. The LEDs light up as soon as the individually defined limit for ends down is exceeded. Thanks to the three-stage display concept, operating personnel are guided to the ends down even more efficiently.

Another function is the permanent monitoring of the speed of each spindle. If a spindle runs outside the defined specifications, this is indicated by the LED flashing. This allows the operator to quickly and easily recognize which spindle is not running correctly. The operator can then intervene immediately, which avoids loss of raw material and quality.

## Options for spinning position identification and roving stop

Using the SPID system of the winding machine Autoconer X6 in linked installations, the winding unit can detect faulty cops and assign it to the defective spinning position. The operator is guided directly to the spinning position that is not operating correctly and can intervene immediately.

ISM premium is the basis for the roving stop device. If ends down occur, the ISM sends a signal to the roving stop device, which stops the roving feed. This saves raw material.

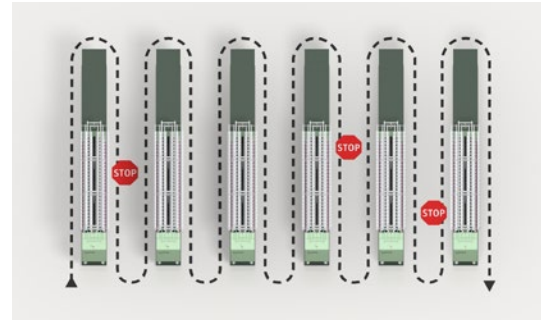
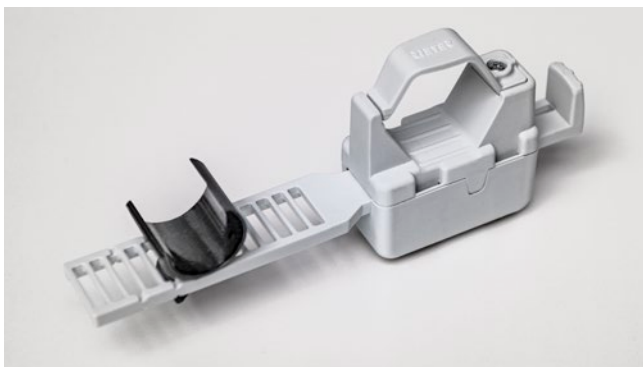

Without individual spindle monitoring – long distances for the operator

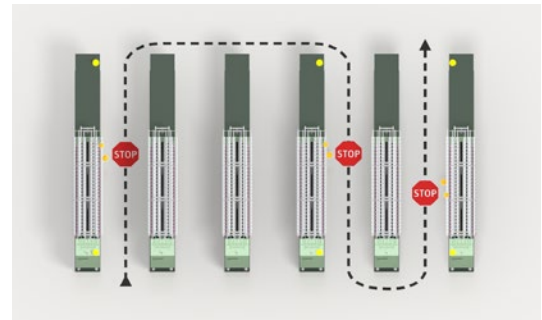

With individual spindle monitoring – optimized path saves time and improves efficiency

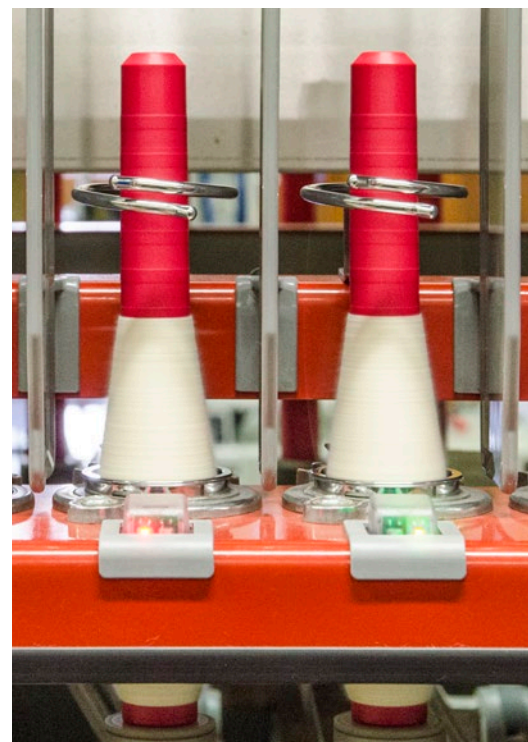

# ESSENTIAL – Rieter Digital Spinning Suite

Rieter’s all-in-one mill management system for production traceability

ESSENTIAL leverages digital technology for the textile value creation. The Rieter Digital Spinning Suite analyzes data of the entire spinning mill in real-time and provides meaningful key performance indicators based on this.

With comprehensive and clearly arranged digital analysis, the system supports management in strengthening the expertise of mill staff, eliminating inefficiencies and optimizing processes across the entire system. Through its holistic approach, ESSENTIAL connects the dots in the spinning mill.

ESSENTIAL is a modular system, so the spinning mill can be gradually digitized.

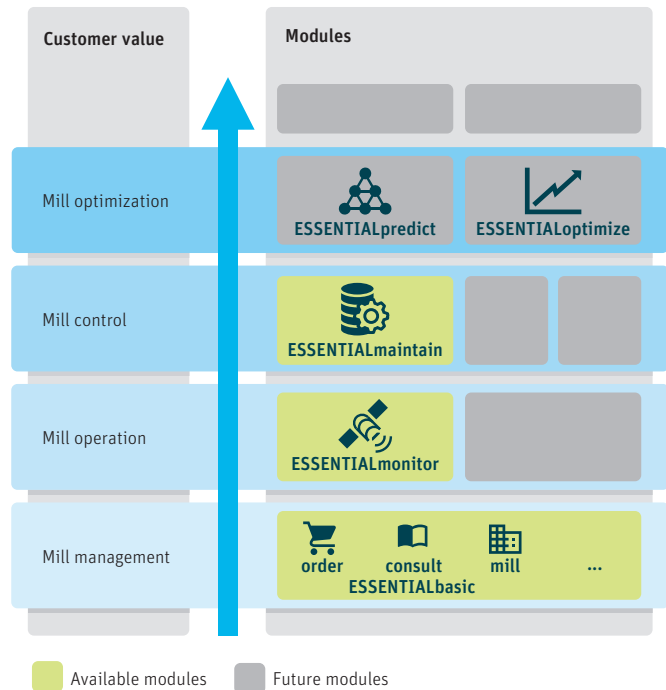

Modular set up of ESSENTIAL



# Highest Level of Spinning Mill Automation

## Intelligent automation

The linking of Rieter ring and compact-spinning machines to the winding machine Autoconer X6 enables the most intelligent process automation.

Cops and tubes circulate directly in a closed process system of ring spinning and winding machines. Customers benefit from intelligent cop and tube logistics with complete material tracking. RFID chips turn peg trays into Smarttrays. Position and status of all cops and tubes is known at all times. RFID is the basis for intelligent lot changes and online yarn quality monitoring.

## Automation solutions Multilink/Multilot

Multilink is characterized by highest throughput rates (up to 60 cops/min for the interface) and for highest productivity (up to 96 winding units). With Multilink, customers can connect up to four ring spinning machines with one winding machine in various positions.

Multilot manages the processing of up to four different materials on one Autoconer. Multilot is unbeatable thanks to the unique color-coded operator guidance, the simple lot handling at the operating unit and the flexible material flow configuration.

## Individual link solutions

Whether direct link or underfloor link: Rieter creates an individual solution, suitable for the requirements of a spinning mill. The new Multilink offers even more flexibility in spinning mill design, with optimum space utilization and cost-saving potential. Links with machines in parallel or serial positioning are possible.

## Process transparency using ESSENTIAL

A much higher level of process optimization can be achieved by integrating the machines into the ESSENTIAL spinning mill management system. The long-term monitoring of the data generated in the spinning and winding process leads to additional benefits.

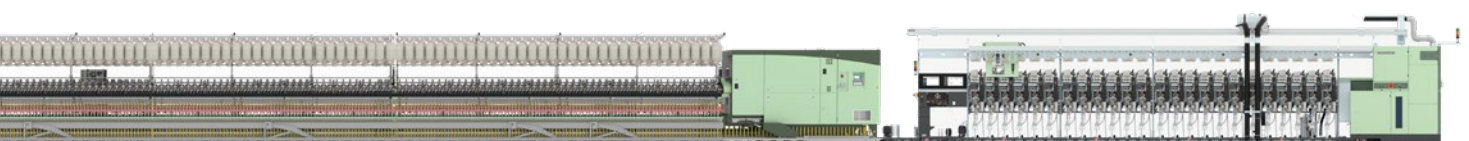



# Minimal Workload

## Flexible automation

Various automation options are available. With the SERVODisc system, the ring spinning machine can either be directly linked with a winding machine or with the tube loader ROBOLoad.



Link to the winding machine with Multilink system

## Tube loader ROBOLoad with add-on system WILDload and trolley

The system WILDload means significantly less work for operating personnel. The tubes are loaded into a trolley at the winding machine which is then clicked directly onto the ROBOLoad. No manual work is required.

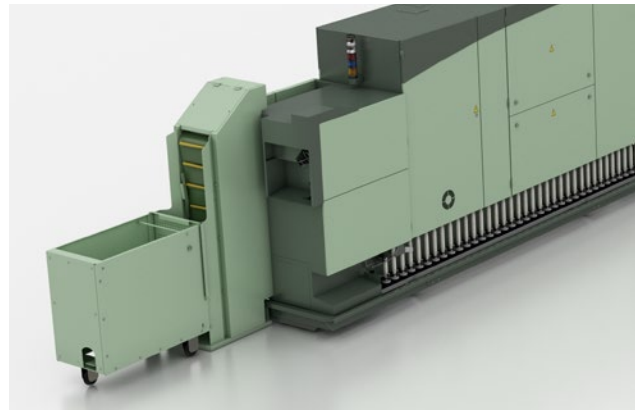

System WILDload: The tubes are picked up one after the other then aligned and fed to the tube loader ROBOLoad.



# Machine Data

## Ring spinning machine G 38

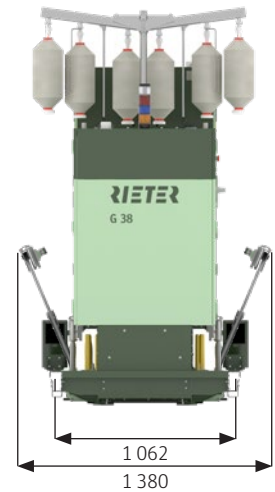
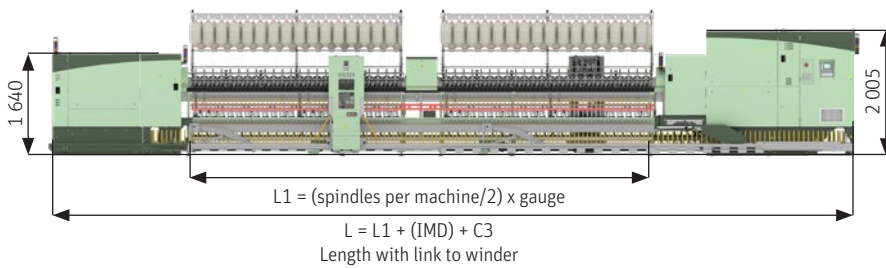
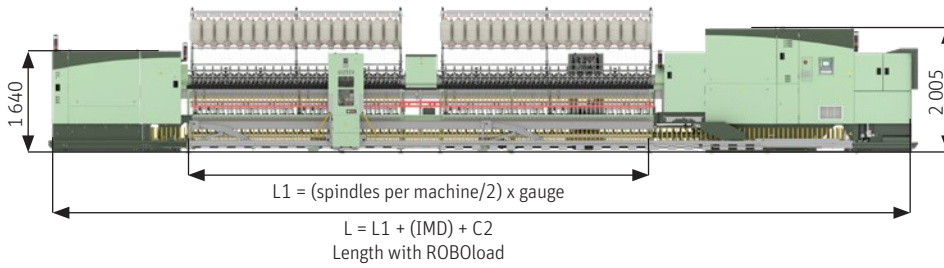
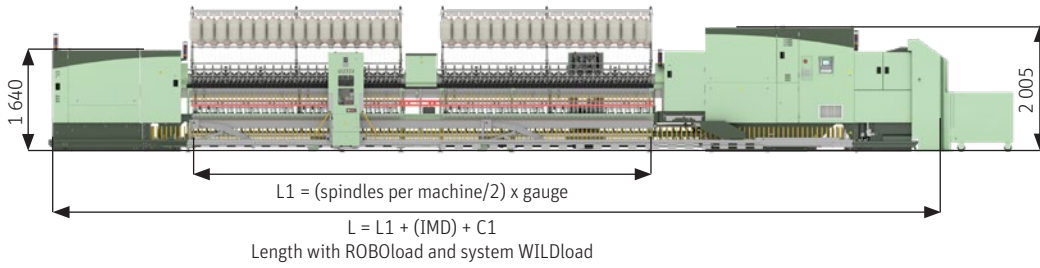

### Machine length L [mm]

$L = (\text{no. spindles}/2 \times \text{gauge}) + \text{intermediate drive (IMD)} + \text{constant (C)}$

### Maximum number of spindles

Up to 1 824 spindles per machine with 70 mm gauge  
 Up to 1 632 spindles per machine with 75 mm gauge

### Machine without intermediate drive (IMD)

Up to 1 248 spindles: all raw materials, 70 and 75 mm gauge  
 Up to 1 440 spindles: 100% cotton, 70 mm gauge

**Length of intermediate drive (IMD): 600 mm**

**Length of ROBload: 1 005 mm**

**Length of add-on system WILDload: 643 mm**

**Length of trolley: 980 mm and 1 200 mm available**

### Endstock length depending on version [mm]

Suction	Single-sided*	Double-sided*
C1: ROBload and system WILDload without trolley	5 828	7 284
C2: ROBload without trolley	5 185	6 641
C3: Link to Rieter, Murata, Savio	4 180	5 636

\*Single-sided suction is available for up to 1 440 spindles. Double-sided suction always has an intermediate drive and is available from 1 296 spindles.

### Example calculation for machine length L [mm]

1 824 spindles, 70 mm gauge, intermediate drive, double-sided suction, link  
 $L = [(1\ 824/2) \times 70] + 600 + 5\ 636 = 70\ 076 \text{ mm}$

Technological data	
<b>Material</b>	Cotton, man-made fibers and blends up to 63 mm (2 1/2 in)
<b>Yarn count</b>	
Standard	All raw materials 132 – 3.7 tex Nm 7.5 – 270 Ne 4.5 – 160
Optional	All raw materials 132 – 2.4 tex Nm 7.5 – 423 Ne 4.5 – 250
<b>Twist range</b>	200 – 3 000 T/m (5.1 – 76.1 T/in)
<b>Draft</b>	8 – 130-fold (mechanical) 10 – 80-fold (technological) 6 – 250-fold (VARIOspin optional)
Machine data	
<b>Number of spindles</b>	
Max.	1 824 with 70 mm gauge 1 632 with 75 mm gauge
Min.	288 (144 on request)
Per section	48
<b>Spindle gauge</b>	70; 75 mm
<b>Ring diameter</b>	
70 mm gauge	34; 36; 38; 40; 42; 45 mm
75 mm gauge	... 42; 45; 48; 51, (54) mm
<b>Tube length</b>	
70 mm gauge	180 – 230 mm
75 mm gauge	220 – 250 mm
<b>Tube and spindle diameter DUI</b>	
DUI 18; DUI 20	Rieter spindle range
DUI 16	LENA 28 spindle with 34 mm ring
<b>Machine width</b>	
Over center of spindle	660 mm
Doffer retracted	1 062 mm
Doffer extended	1 380 mm
ROBOspin data (option)	
Machine width with ROBOspin	1 586 mm
Compressed air Min. supply pressure	7 bar
Installed power	2 x 0.48 kW

Technical data	
<b>Spindle speed</b>	Mechanical up to 28 000 rpm
<b>Installed power</b>	
<b>Main drive motor</b> depending on spindle number	55 kW 75; 90; 110 kW (IE4)
<b>Drafting system drive</b>	
Standard	5 – 15.1 kW
VARIOspin	4.38 – 16.72 kW
Without IMD	4.4 – 8.8 kW
<b>Ring rail drive</b>	1.75 kW
<b>Single-sided suction on the power supply (50/60 Hz)</b>	
up to 1 200 spindles	6.5 kW
1 248 – 1 440 spindles	9.0 kW
1 488 – 1 632 spindles	12.6 kW
<b>Single-sided suction with converter</b>	
Up to 1 008 spindles	6.5 kW
1 056 – 1 440 spindles	12.6 kW
<b>Double-sided suction with converter</b>	
1 296 – 1 824 spindles	2 x 6.5 kW
<b>Mains connection</b>	
Rated voltage	380 – 440 V; 50/60 Hz Other rated voltages available on request
<b>Compressed air</b>	
Min. supply pressure	7 bar
Consumption	approx. 1.5 Nm <sup>3</sup> /h (up to 1 440 spindles) approx. 1.75 Nm <sup>3</sup> /h (up to 1 632 spindles) approx. 2 Nm <sup>3</sup> /h (up to 1 824 spindles)
<b>Exhaust air</b>	
Air volume with single-sided suction	9 400 m <sup>3</sup> /h with 1 632 spindles
Air volume with double-sided suction (even split of air flow rate in the head and foot of the machine)	9 400 m <sup>3</sup> /h with 1 632 spindles 10 500 m <sup>3</sup> /h with 1 824 spindles
Options	
<ul style="list-style-type: none"> <li>• COMPACTdrum</li> <li>• COMPACTeasy</li> <li>• Twin yarn</li> <li>• Core yarn device</li> <li>• Slub yarn VARIOspin</li> <li>• Q-Package</li> <li>• Man-made fiber package</li> </ul>	<ul style="list-style-type: none"> <li>• High-Speed Package</li> <li>• LENA 28 spindles (DUI 18; DUI 16)</li> <li>• 75; 90; 110 kW IE4 equivalent main motor</li> <li>• Power monitoring</li> <li>• ROBOspin</li> </ul>
	<ul style="list-style-type: none"> <li>• ISM basic</li> <li>• DOFFlock</li> <li>• ROBOload with system WILDload</li> <li>• Roving stop device</li> <li>• ESSENTIAL</li> </ul>

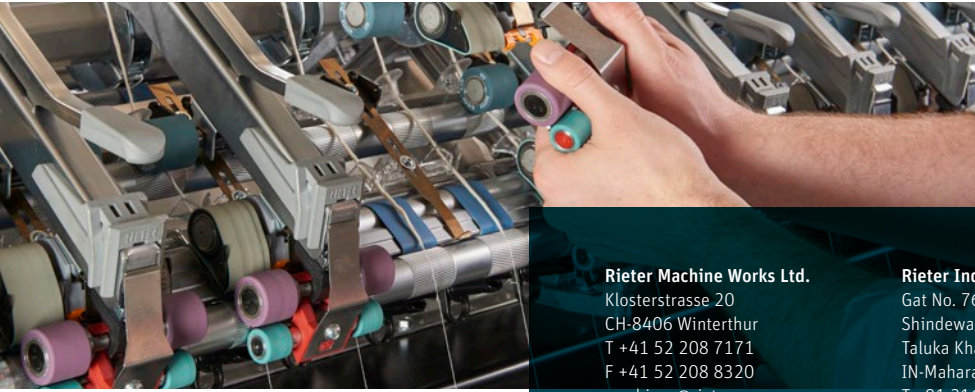

**Rieter Machine Works Ltd.**

Klosterstrasse 20  
CH-8406 Winterthur  
T +41 52 208 7171  
F +41 52 208 8320  
machines@rieter.com  
aftersales@rieter.com

**Rieter India Private Ltd.**

Gat No. 768/2, Village Wing  
Shindewadi-Bhor Road  
Taluka Khandala, District Satara  
IN-Maharashtra 412 801  
T +91 2169 664 141  
F +91 2169 664 226

**Rieter (China) Textile  
Instruments Co., Ltd.**

390 West Hehai Road  
Changzhou 213022, Jiangsu  
P.R. China  
T +86 519 8511 0675  
F +86 519 8511 0673

[www.rieter.com](http://www.rieter.com)



The data and illustrations in this brochure and on the corresponding data storage device refer to the date of printing. Rieter reserves the right to make any necessary changes at any time and without special notice. Rieter systems and Rieter innovations are patent protected.

3236-v4 en 2311